

Lecture Atmospheric Physics

University of Bremen
Master of Environmental Physics
WS 2003 / 2004

Andreas Richter
room U2090, tel. 4474
richter@iup.physik.uni-bremen.de

Tutorial:

Oluyemi Afe
room U2080, tel. 7421
afe@iup.physik.uni-bremen.de

Contents:

1. Survey of the Atmosphere
2. Radiation in the Atmosphere
3. Climate Change
4. Atmospheric Thermodynamics and the role of Water Vapour
5. Introduction to Dynamics of the Atmosphere

Disclaimer

This file contains the lecture notes for the Atmospheric Physics lecture given at the University Bremen during the winter term 2003 / 2004. This is not a book, and much of the information given in the lecture is missing. Also, many figures and explanations were taken from books, articles and web pages without proper reference. In particular, many parts are based on the script by K. Künzi and S. Bühler.

The contents of this file may therefore used only for educational purposes.

There probably are errors, omissions, inconsistencies and confusing explanations in these lecture notes. If you find any of these, please send an email to

Andreas.Richter@iup.physik.uni-bremen.de

The Rules of the Game:

Lectures:

- 13 lectures, every Wednesday
- one “rapporteur” gives brief summary from last lecture

Exercises:

- 10 exercises
- will be distributed in the lecture
- will have to be submitted on the next Tuesday (6 days to work on it...)
- no copies, joined solutions, cryptic notes please!
- will be returned and discussed on the next day in the tutorial after the lecture
- credits: $10 \times 10 = 100$

Exam:

- prerequisite to take part in the exam:
 - **at least 75 credits from exercises**
 - **acted at least once as rapporteur**
- 2 hours written exam in the first or second week after the end of lectures

Literature for the Lecture

English Books:

Houghton, J.T., The physics of atmospheres, Cambridge University Press, 1977, ISBN 0 521 29656 0

Wallace, John M. and Peter V. Hobbs, Atmospheric Science, Academic Press, 1977, ISBN 0-12-732950-1

Deutsche Bücher:

Roedel, Walter, Physik unserer Umwelt, Die Atmosphäre, Springer Verlag, 1992, ISBN 3-540-54285-X

Script:

Environmental Physics I, WS 2002/2003, Klaus Künzi and Stefan Bühler, Institute of Environmental Physics, University of Bremen, Bremen; Germany

Schematic Overview

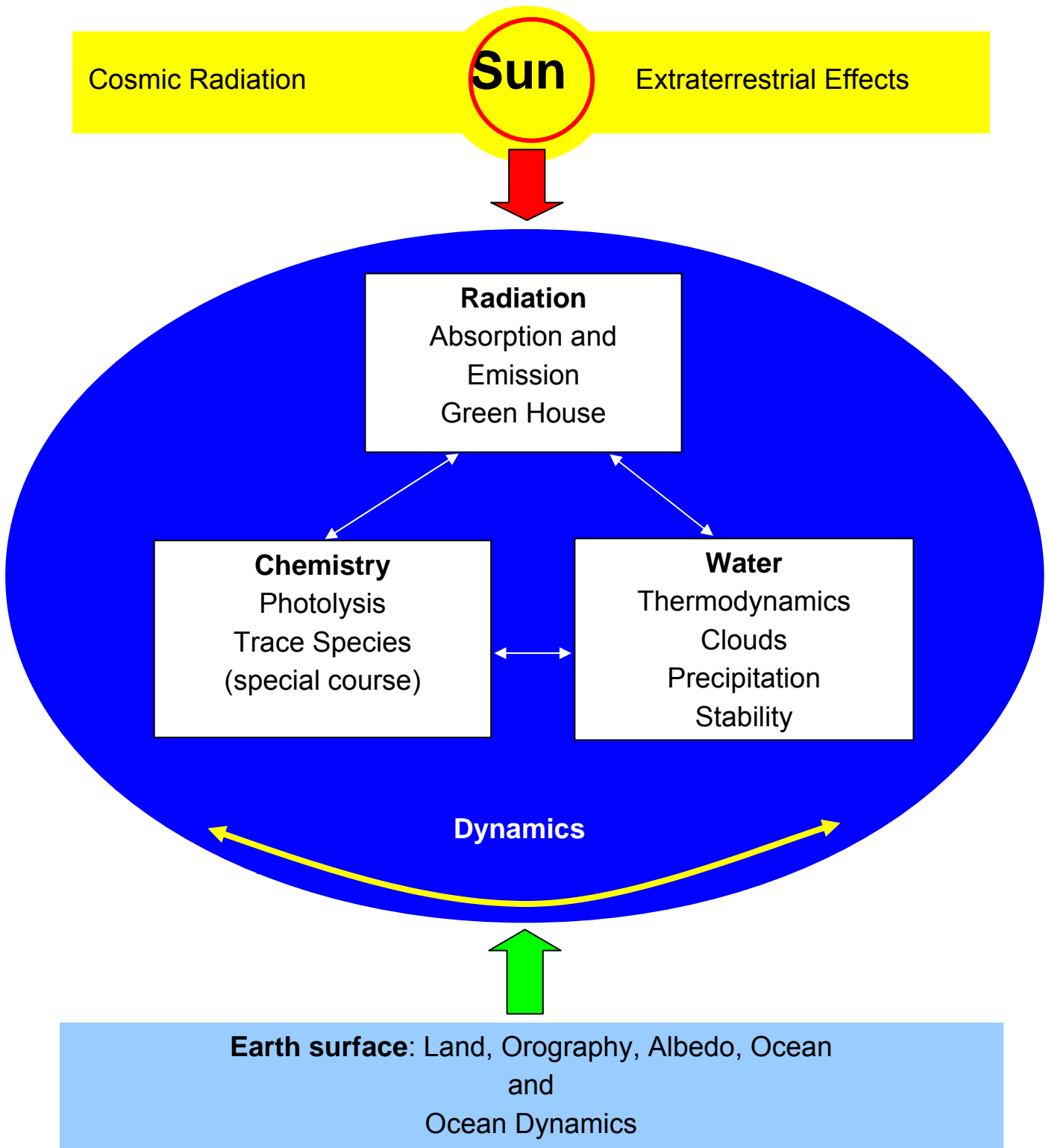

Atmospheric Composition Today

Constituent	Molecular Weight [g / mol]	Content (fraction of molecules)
Nitrogen (N ₂)	28.016	0.7808
Oxygen (O ₂)	32.00	0.2095
Argon (Ar)	39.94	0.0093
Water vapour (H ₂ O)	18.02	0 - 0.04
Carbon Dioxide (CO ₂)	44.01	325 ppm
Neon (Ne)	20.18	18 ppm
Helium (He)	4.00	5 ppm
Krypton (Kr)	83.7	1 ppm
Hydrogen (H ₂)	2.02	0.5 ppm
Ozone (O ₃)	48.00	0 - 12 ppm

- most constituents are very stable in concentrations
- exception: H₂O and O₃ that vary rapidly in space and time and CO₂, that increases slowly as a result of anthropogenic emissions
- many other trace gases are present in the atmosphere however in small and variable concentrations

Planetary Atmospheres

Planet	Gravitation (relative)	Temperature at Surface [K]	Surface Pressure [10^3 hPa]	Composition
Venus	0.91	700	100	CO ₂ > 90%
Earth	1	290	1	N ₂ (~ 78 %) O ₂ (~ 21 %)
Mars	0.38	210	0.01	CO ₂ (> 80 %)

- Earth's atmosphere is unique in pressure, temperature and atmospheric composition

Origin of the Atmosphere

- at the time of formation (4.5×10^9 years ago), earth had no or little atmosphere
- the atmosphere was formed from volatile emissions from the interior of the earth (volcanic activity)
- volcanic emissions are roughly 85% H_2O , 10% CO_2 , and a few per cent sulphur compounds

Questions:

- where is the CO_2 ?
 - in carbonates in the earth's crust
- where is the H_2O ?
 - deep ocean leakage
 - photodissociation?
- where is the O_2 coming from?
 - photodissociation $2\text{H}_2\text{O} + h\nu \rightarrow 2\text{H}_2 + \text{O}_2$
 - photosynthesis $\text{H}_2\text{O} + \text{CO}_2 \rightarrow \{\text{CH}_2\text{O}\} + \text{O}_2$
- where is the N_2 coming from?
- where are the noble gases coming from?
 - radioactive decay

The Carbon Budget

- in photosynthesis, carbon is incorporated into organic compounds
- a small part of this organic matter is not oxidized, but fossilized in shales or fossil fuels
- 90% of the O₂ produced by photosynthesis is stored in the earth's crust in oxides such as FeO₃ or carbonate compounds such as CaCO₃, Fe₂O₃, or MgCO₃
- the carbonates are the main sink of atmospheric CO₂

Substance	Fraction [%]
Rocks	71
Shales	29
Ocean, dissolved CO ₂	0.1
Oil, gas, coal	0.03
Atmosphere (CO ₂)	0.003
Biosphere	7x10 ⁻⁵

Inputs / Outputs to the Atmosphere

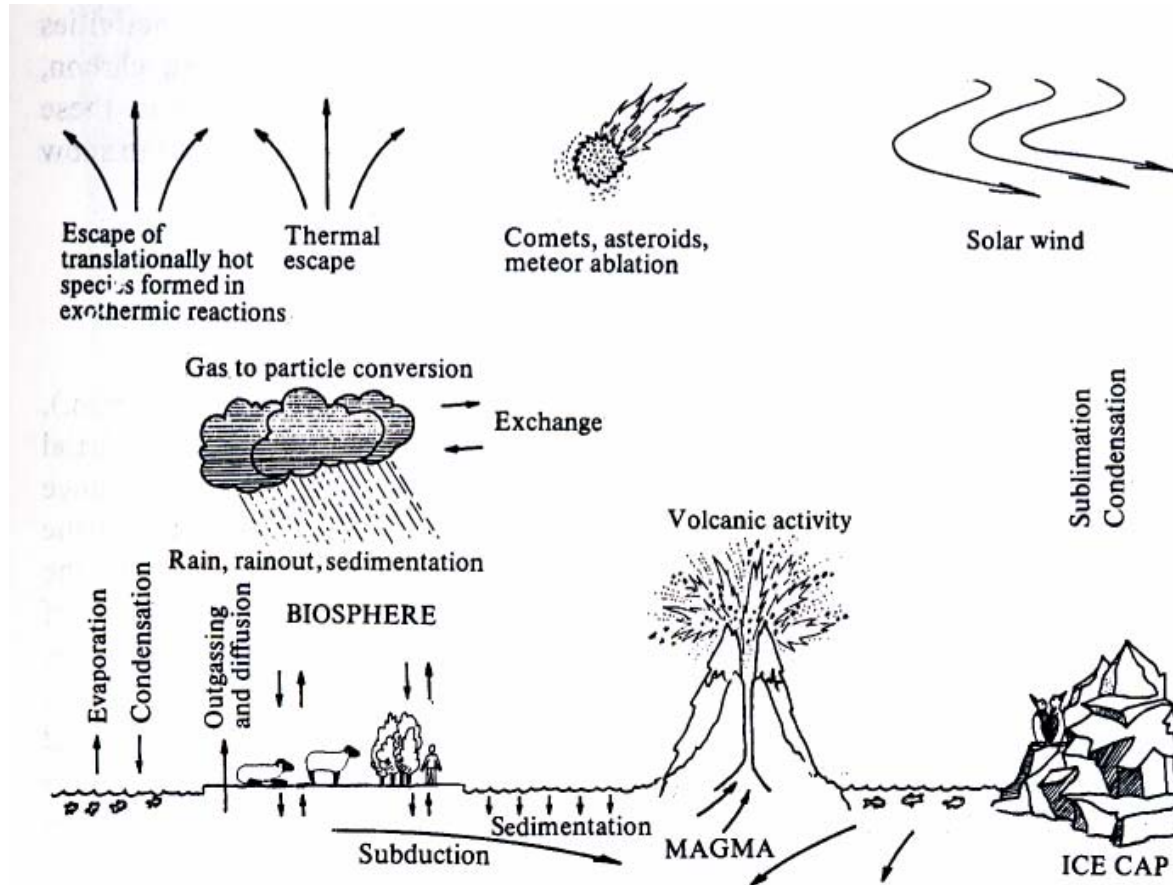

- Input from volcanic activity
- Input from meteorites
- Exchange with Biosphere
- Exchange with Hydrosphere
- Loss to outer space and earth

Impact of Biosphere

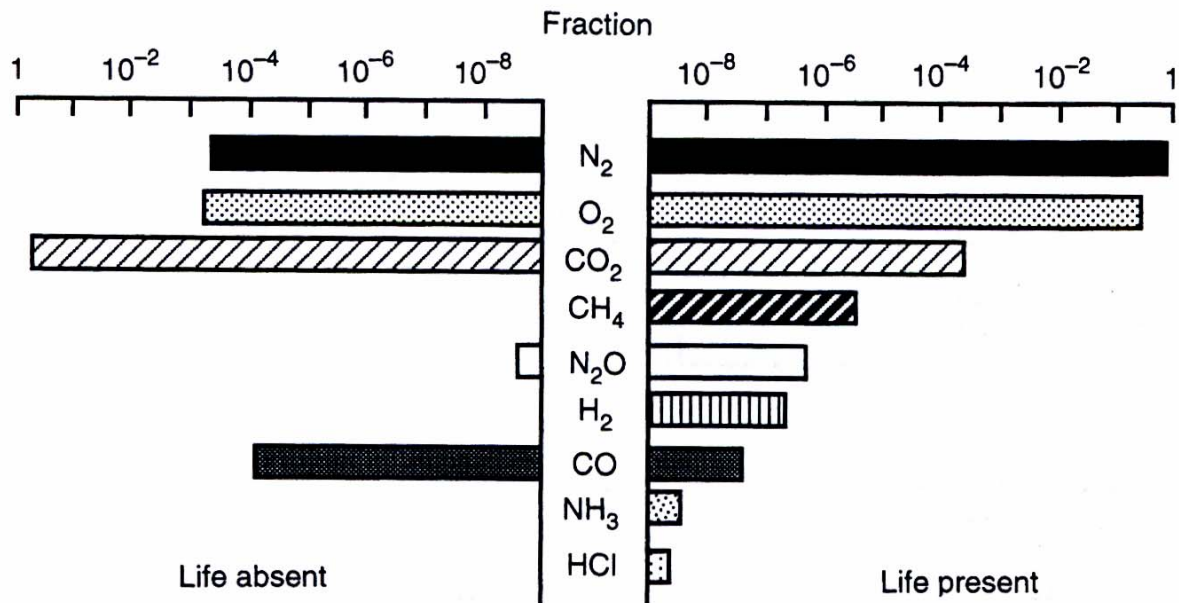

- The Earth's atmosphere is far away from the equilibrium expected for a planet without life.
- The disequilibrium is sustained by permanent emissions and adsorptions of species by the biosphere.
- Many feedback mechanisms are known through which the atmosphere is kept in its current state (CO₂ from weathering of silicate rocks by soil bacteria, cloud nucleation from DMS emitted from the oceans, ozone layer, ...)
- Provokingly, the atmosphere can be seen as part of the biosphere (**Gaia hypothesis**)

Anthropogenic Impacts

Humankind is changing atmospheric composition by

- emissions of particulates (20% of total)
- burning of fossil fuels which has a direct impact on CO₂ concentrations (1000 years of photolysis undone per year!)

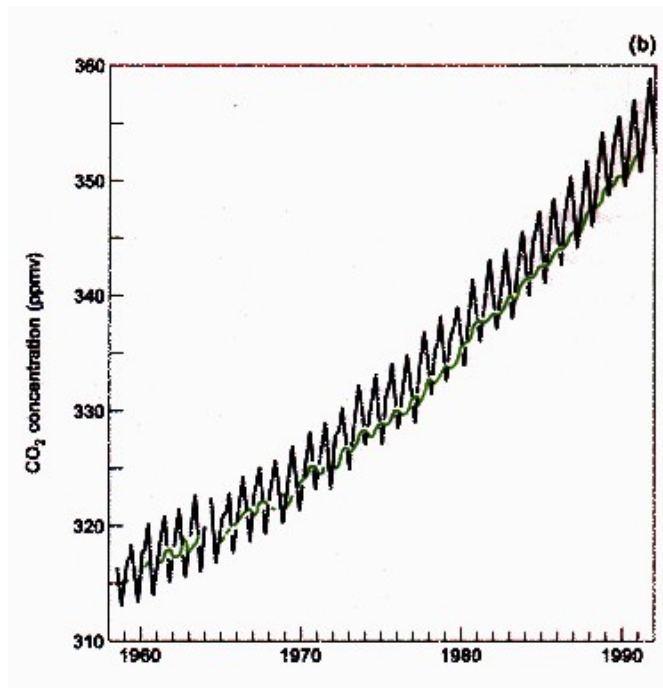

- emissions of trace species that alter atmospheric chemistry in many ways
- emission of trace species that alter the radiative properties of the atmosphere directly or indirectly (cloud formation or change)
- direct or indirect changes of temperature

Role of Water in the Atmosphere

Water in the atmosphere is of particular importance as

- concentration varies strongly with height, location, temperature,...
- it is present in all three phases (solid, liquid, gaseous) in the atmosphere and the hydrosphere in general
- condensation and evaporation is connected with large changes in latent heat that are crucial for energy transport in the atmosphere, and are the driver for atmospheric dynamics
- water vapour concentration determines the vertical profile of temperature in the atmosphere
- rain is essential for the removal of particles and many gases from the atmosphere
- it is playing an important role in the greenhouse effect

Water Vapour in Atmospheres

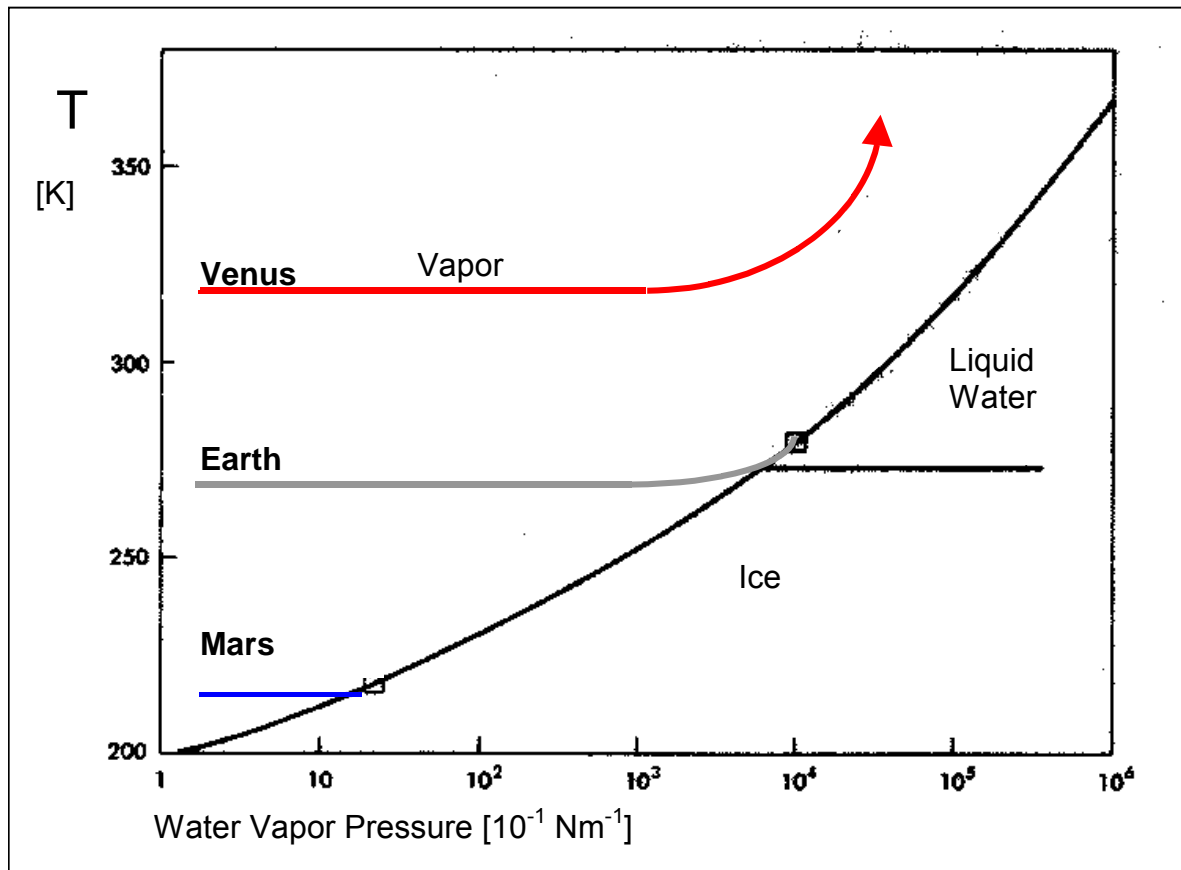

- Earth is the only planet in the solar system where water can exist in all three phases.
- Most of the water emitted by volcanoes in Earth's history is missing (99%)
- Only a very small fraction of the water is in the atmosphere (97% in oceans, 2.4% in ice, 0.6% in underground fresh water, 0.02% in lakes and rivers, and 0.001% the atmosphere)

The Atmosphere in Perspective

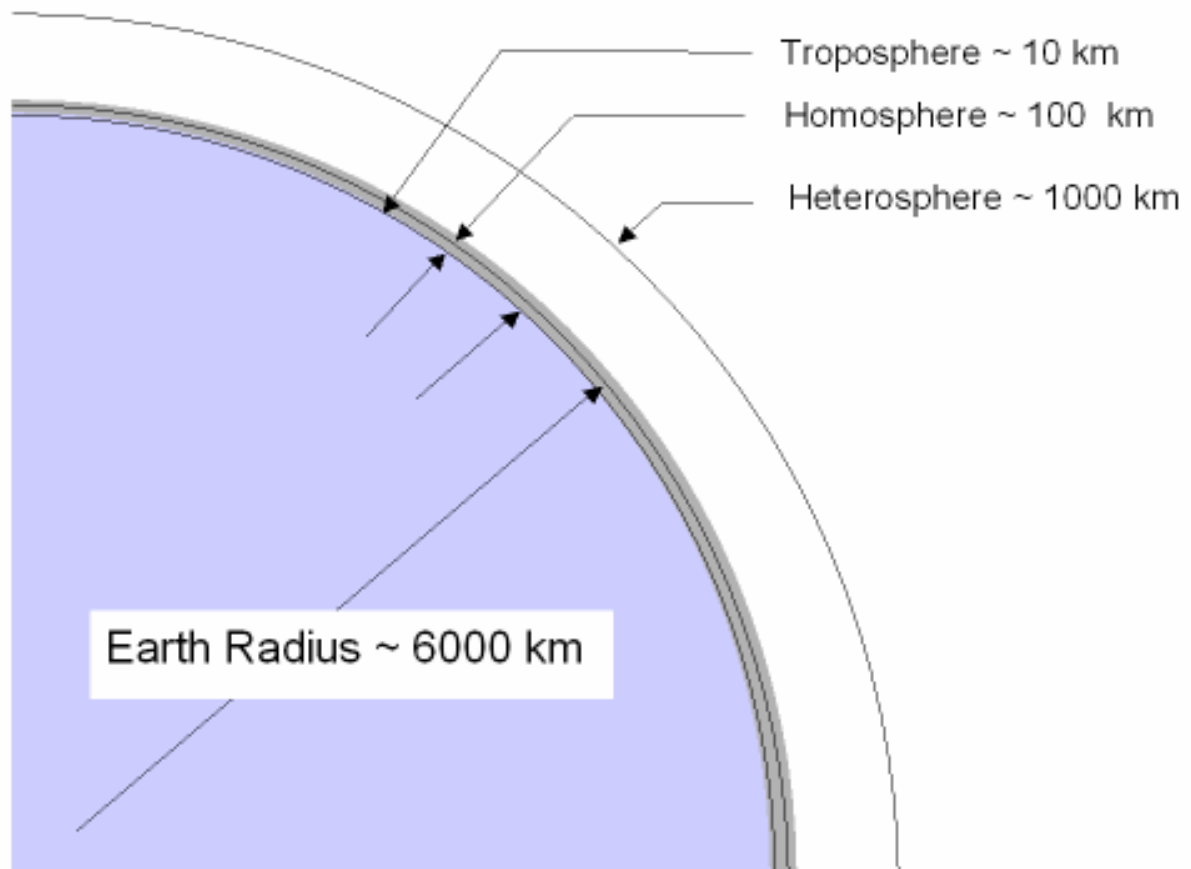

The atmosphere

- is exceedingly thin
- contains only a minute fraction of the Earth's mass (0.025%), even for its main constituents
- **Lithosphere** (the earth's crust), **Hydrosphere** (water on or above the earth's surface) and **Biosphere** (all animal and plant life) act as huge reservoirs for atmospheric constituents

Vertical Structure of the Atmosphere

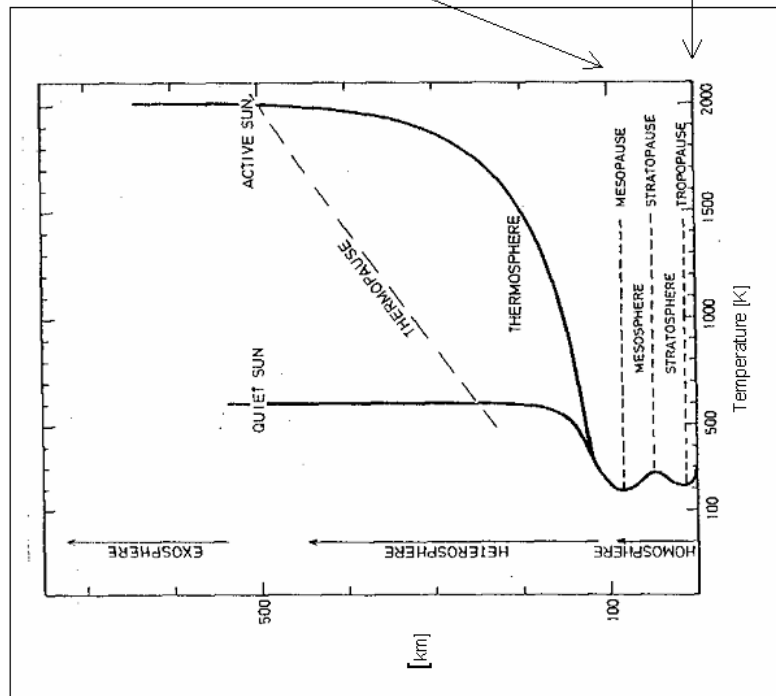
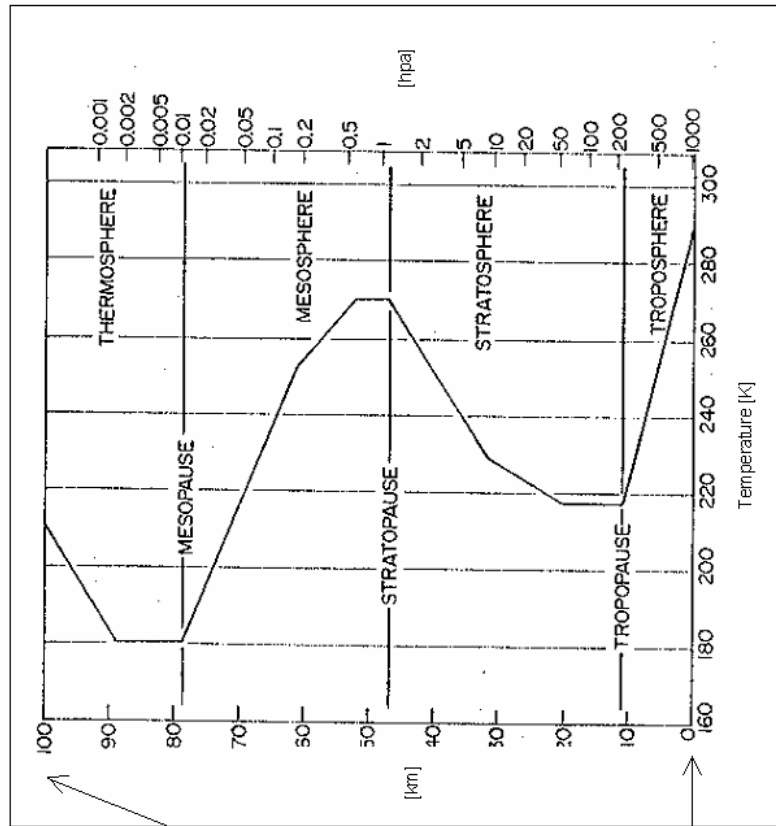

Vertical Structure of the Atmosphere

Classification according to T-profile:

- Troposphere
- Stratosphere
- Mesosphere
- Thermosphere
- Exosphere

Boundaries between layers are called “-pause”;
most important here: the tropopause

Tropopause varies with season, latitude,
temperature and pressure systems

Different tropopause definitions based on T, O₃,
potential temperature, H₂O, or combinations of the
above.

Classification according to mixing:

- Homosphere
- Heterosphere

Vertical Structure of the Atmosphere

Reasons for the temperature profile:

- adiabatic vertical transport
- radiative cooling by water vapour
- absorption in the ozone layer
- oxygen absorption in the thermosphere

Consequences of the temperature profile:

- strong mixing in the troposphere
- low vertical mixing in the stratosphere
- very low humidity in the stratosphere (tropopause acts as a cooling trap)
- troposphere and stratosphere are largely separated regions of the atmosphere, and exchange between the two is limited to specific regions:
 - through convection in the tropics
 - in tropopause folds
 - through subsidence in polar regions

Abundance Units in Atmospheric Science

quantity	symbol	units
number of molecules	N	mol = 6.022×10^{23}
number density	n	particles / m ³
mass density	ρ	kg / m ³
volume mixing ratio	μ	ppmV = 10^{-6} ppbV = 10^{-9} pptV = 10^{-12}
mass mixing ratio	μ	ppmm = 10^{-6} ppbm = 10^{-9} pptm = 10^{-12}
column abundance		molec/cm ² or DU = 10^{-3} cm at STP

Ideal Gas

Assumptions:

- ensemble of individual molecules
- no interaction apart from collision
- no chemical reactions
- no appreciable volume of individual molecules

State properties of a gas: p , T , V , and n

Equation of state for the ideal gas:

$$pV = nRT \quad \text{or} \quad pV = NkT$$

p = pressure, V = volume, n = number of moles,
 N = number of molecules, R = universal gas constant,
 k = Boltzmann constant, T = temperature

All gases act as ideal gases at very low pressure; to good approximation, gases in the atmosphere can be treated as ideal gases with the exception of water vapour (phase changes)

Deriving the Equation of State

Temperature T is a measure of the average kinetic energy of the molecules:

$$\bar{E}_{kin} = \frac{3}{2}kT$$

$$\bar{E}_{kin} = \frac{1}{2}m\bar{v}^2$$

m = mass of the molecule, \bar{v} = average speed

Thus, the average speed of a molecule depends on temperature and mass:

$$\bar{v}^2 = \frac{3kT}{m}$$

i.e. heavy molecules move slower than light ones.

The kinetic pressure (momentum transfer per collision) is

$$p = \frac{F}{A} = \frac{d(mv)}{Adt}$$

A = area, F = force

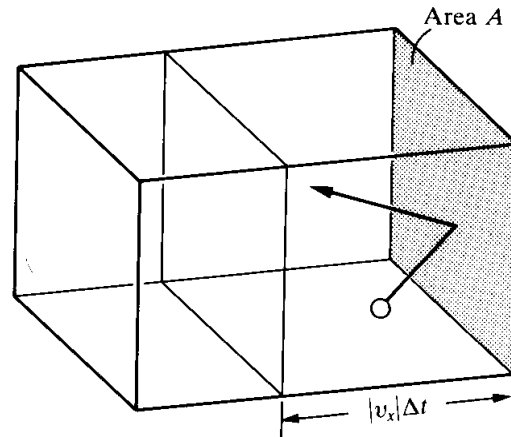

Change of momentum ΔP for one collision with wall:

$$\Delta P = 2m|v_x|$$

The number of collisions in an interval Δt is the number of molecules contained in the distance that the molecules travel in Δt times the area of the wall

$$\frac{N}{V} A |v_x| \Delta t$$

On average, half of the molecules move to the left, half to the right

$$\frac{N}{2V} A |v_x| \Delta t$$

The total momentum change then is

$$\frac{N}{2V} A \Delta t 2m v_x^2$$

the rate of change is

$$\frac{N}{V} A m v_x^2$$

and the pressure $p = F/A$

$$p = \frac{N}{V} m v_x^2$$

Not all particles travel at the same speed, so the average pressure is

$$p = \frac{N}{V} m \overline{v_x^2}$$

If we consider that no direction is special

$$\overline{v^2} = \overline{v_x^2} + \overline{v_y^2} + \overline{v_z^2} = 3\overline{v_x^2}$$

we can express the average speed in x-direction

by $\frac{1}{3}\overline{v^2}$. Combining now the equation for pressure

with the relation between speed and temperature, we get

$$p = \frac{N}{V} \overline{v_x^2} = \frac{N}{3V} \overline{v^2} = \frac{NkT}{V}$$

Mixtures of Ideal Gases

Dalton's law: The pressure exerted by a mixture of perfect gases is the sum of the pressures exerted by the individual gases occupying the same volume alone or

$$p = p_A + p_B$$

Mole fraction: The mole fraction of a gas X in a mixture is the number of moles of X molecules present (n_X) as a fraction of the total number of moles of molecules (n) in the sample:

$$x_X = \frac{n_X}{n} \quad \text{with } n = n_A + n_B + n_C + \dots$$

Partial pressure: The partial pressure of a gas in a mixture is *defined* as the product of mole fraction of this gas and total pressure of the gas:

$$p_x = x_X p$$

Excursion: Ideal Gas Law

The ideal gas law can be expressed in molecules or moles:

$$pV = nRT \quad \text{or} \quad pV = NkT$$

R or R^* = **Universal gas constant** = $8.314 \text{ J mol}^{-1} \text{ K}^{-1}$

k = **Boltzmann's constant** = $1.381 \cdot 10^{-23} \text{ J molec}^{-1} \text{ K}^{-1}$

N_A = **Avogadro's number** = $6.022 \cdot 10^{23} \text{ mol}^{-1}$

$$R = N_A k$$

Number density:

$$\frac{N}{V} = \frac{p}{kT}$$

Mass density:

$$\rho = \frac{m}{V} = \frac{Nm_x}{V} = \frac{m_x p}{kT} = \frac{M_x p}{N_A kT} = \frac{M_x p}{RT}$$

m_x = Mass of one molecule x , M_x molar mass of x

In some books, individual gas constants are defined for each gas:

$$R_x = \frac{R}{M_x}$$

Virtual Temperature:

Problem: The molecular weight of air is not constant, but changes with water vapour pressure

Solution: Define a fictitious virtual temperature, that dry air must have to have the same density that the moist air has at a given pressure.

The density of moist air is

$$\rho = \frac{m_d + m_{H_2O}}{V} = \rho_d' + \rho_v'$$

m_d = mass of dry air, m_{H_2O} mass of water vapour

where ρ_d' is the density dry air would have if it would occupy the volume alone.

From the ideal gas equation, the partial pressures of water vapour e and dry air p_d can be derived:

$$e = \rho_v' TR / M_{H_2O}$$

$$p_d' = \rho_d' TR / M_{air}$$

and total pressure is $p = p_d' + e$

Inserting into the equation for the density

$$\rho = \frac{M_d(p - e)}{TR} + \frac{eM_{H_2O}}{RT}$$
$$\rho = \frac{M_d p}{RT} \left(1 - \frac{e}{p} (1 - \varepsilon) \right) \text{ with } \varepsilon = \frac{M_{H_2O}}{M_d} = 0.622$$

If we now define a **virtual Temperature T_v** as

$$T_v = \frac{T}{1 - (e/p)(1 - \varepsilon)}$$

we can write the equation of state for moist air in the ideal gas form using the molecular weight of dry air:

$$\rho = \frac{R \rho T_v}{M_d}$$

Moist air is less dense than dry air, therefore the virtual temperature is always larger than the real temperature (the difference is usually small). In the future, virtual temperature will be used throughout without special notice.

Hydrostatic Equation I

$$dp = -\rho \cdot g \cdot dz$$

Ideal gas

$$p \cdot V = nR \cdot T$$

Definition of density:

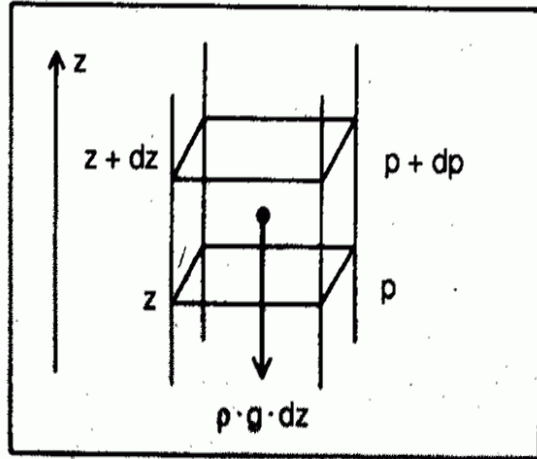

$$\rho = \frac{n \cdot M}{V} = \frac{M \cdot p}{R \cdot T}$$

Insert:

$$dp = -p \cdot \frac{M \cdot g}{R \cdot T} \cdot dz$$

Integrate:

$$p = p_0 \exp\left(-\frac{M \cdot g}{R \cdot T} \cdot z\right)$$

p = pressure M = molar air mass,

g = gravitational acceleration,

R = universal gas constant, T = temperature, z = height,

V = volume, ρ = density

In this derivation, the hydrostatic equation follows from an equilibrium between ideal gas pressure and the gravitational force of the total mass of air above. Thus, M is the apparent molar weight of air, and no separation occurs between the constituents.

We have also tacitly assumed that

- temperature and
- gravitational acceleration

do not depend on altitude although that's clearly not true!

Accounting for the temperature profile:

$$\frac{dp}{p} = -\frac{Mg}{RT(z)} dz$$

$$\int_0^z \frac{dp}{p} = -\frac{Mg}{R} \int_0^z \frac{dz'}{T(z')}$$

Defining the harmonic mean of T $\overline{\left(\frac{1}{T}\right)} = \frac{1}{z} \int_0^z \frac{dz'}{T(z')}$

$$p = p_0 \exp\left(-\frac{Mg}{R} \overline{\left(\frac{1}{T}\right)} z\right)$$

Conclusions for the atmospheric pressure profile:

- exponential decay with height
- decay is faster at low temperatures
- harmonic mean of T needed instead of arithmetic mean (difference is usually small)
- on larger planets (larger g) pressure decreases faster

Hydrostatic Equation II

Alternative derivation using Boltzmann statistic:

Assume an infinitely high column of air with N_0 molecules/area. The potential Energy of one molecule is $E_{pot} = mgz$

The Boltzmann distribution gives the number of molecules in a given energy interval as a function of Temperature:

$$dN(E) = C \exp\left(-\frac{E}{kT}\right) dE$$

With $\int dn = N_0$ we can determine C to $C = \frac{N_0}{kT}$

Expressing E as function of z

$E = mgz$ and $dE = mg dz$ yields

$$\begin{aligned} dN(z) &= N_0 \frac{mg}{kT} \exp\left(-\frac{mg}{kT} z\right) dz \\ &= \frac{N_0}{z_0} \exp\left(-\frac{z}{z_0}\right) dz \end{aligned}$$

where z_0 is the scale height.

Considering that $n(z) = dN(z)/dz$, and setting $n_0 = N_0 / z_0$ we obtain

$$n(z) = n_0 \exp\left(-\frac{z}{z_0}\right)$$

At constant temperature, $n(z)/n_0 = p(z)/p_0$ and we obtain the barometric equation. In the real atmosphere, pressure will deviate from this formula depending on the T-profile.

This formula, however, is valid for each component of air independently, and heavy gases are closer to the surface than light ones!

Geopotential

Definition: The **Geopotential** Φ of any point in the atmosphere is the work that must be done against the earth's gravitational field in order to raise a mass of 1 kg from sea level to the point.

$$d\Phi = mgdz = gdz$$

and setting $\Phi(0) = 0$

$$\Phi(z) = \int_0^z g(z)dz$$

- Φ does not depend on the path used to move a mass from the sea surface to a point
- the differences in geopotential between two points $\Phi_B - \Phi_A$ is the work in the gravitational field needed to move a mass of 1 kg from point A to point B

The geopotential depends on altitude as a result of the distance dependence of the gravitational force.

The geopotential also depends on latitude mainly because of the flattening of earth at the poles and the latitudinal dependence of the centrifugal force.

From the geopotential, we can also define a **Geopotential Height**

$$Z = \frac{\Phi(z)}{g_0} = \frac{1}{g_0} \int_0^z g(z) dz$$

where $g_0=9.8 \text{ ms}^{-2}$ is the globally averaged gravitational acceleration at sea surface level.

Geopotential height is used as vertical coordinate in most atmospheric applications where energy plays an important role.

Measuring the Geoid

The 0-point of the geopotential, the geoid also varies with location, mainly as a result of uneven mass distribution in the earth. It can be measured for example from the twin satellites GRACE which monitor their distance (roughly 120 km) with high accuracy. The resulting gravity anomaly (effects of oblateness already subtracted) is important for ocean currents and sea ice mass.

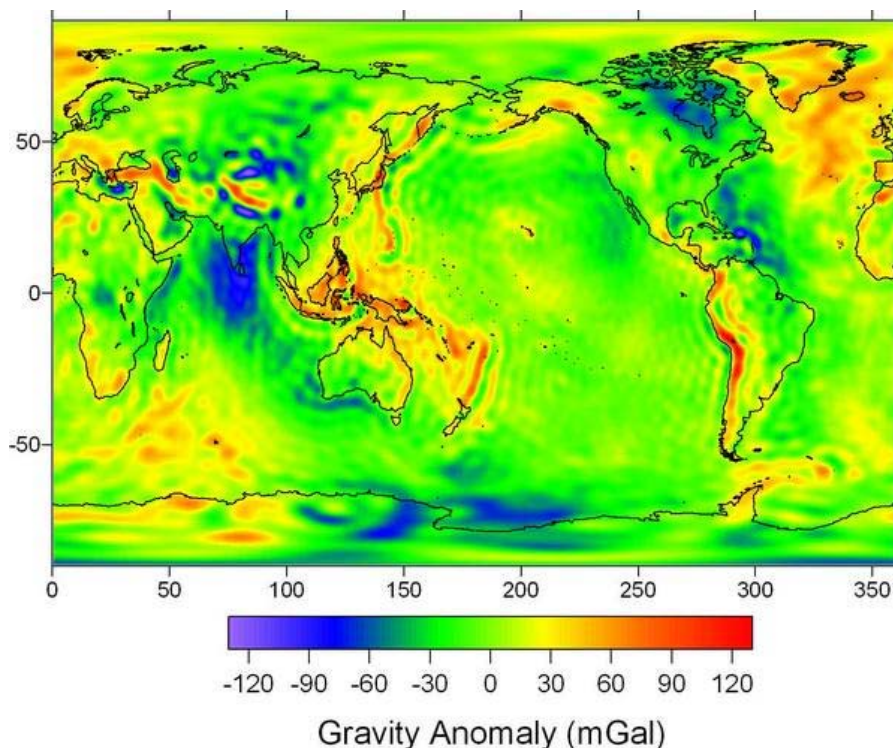

Scale Height

The factor in the exponent in the hydrostatic equation

$$p = p_0 \exp\left(-\frac{M \cdot g}{R \cdot T} \cdot z\right)$$

has the units of inverse length and is called the **Scale Height:**

$$z_0 = \frac{RT}{Mg}$$

Often, the hydrostatic equation is expressed as

$$p = p_0 \exp(-z / z_0)$$

The scale height is the height at which pressure is reduced by a factor of e (2.718); for the atmosphere as a whole it is about 8km which corresponds to a reduction to half the value at 5.5 km.

The scale height depends on M and thus is different for different species; also, it depends on T and thereby altitude.

Examples for scale heights:

Different Planets:

Planet name	Major atmospheric constituent	M [g]	g_0 [m/s²]	T_{surf}_e [K]	H [km]
Venus	CO ₂	44	8.9	700	14.9
Earth	N ₂ ,O ₂	29	9.8	270	7.9
Mars	CO ₂	44	3.7	210	10.6
Jupiter	H ₂	2	26.2	160	25.3

Different Species

Species	Molecular Mass M [g]	Scale height H in [km]
Argon (Ar)	40	21
Nitrogen (N ₂)	28	30
Atomic Oxygen (O)	16	54
Atomic Hydrogen (H)	1	850

Isobaric Atmosphere

It is sometimes useful to imagine an atmosphere where everything is brought to surface pressure (and temperature). In such a model atmosphere, the density is constant and equal to the surface density ρ_0 .

The thickness of this atmosphere can be derived from evaluating the total mass

$$\begin{aligned}M_0 &= \int_0^{\infty} \rho(z) dz = \rho_0 \int_0^{\infty} \exp(-z / z_0) dz \\ &= \rho_0 z_0\end{aligned}$$

and is identical to the scale height z_0 .

This relation is sometimes used to define a scale height for constituents with arbitrary vertical profiles $c(z)$:

$$z_0 = \frac{1}{c_0} \int_0^{\infty} c(z) dz$$

where c_0 is the concentration at the surface.

Distributions of Speed

The **Maxwell-Boltzmann distribution** of speed is

$$f(v_x) = \left(\frac{m}{2\pi kT} \right)^{1/2} e^{-mv_x^2 / 2kT}$$

The **Maxwell distribution** of speeds is

$$f(v) = 4\pi \left(\frac{m}{2\pi kT} \right)^{3/2} v^2 e^{-mv^2 / 2kT}$$

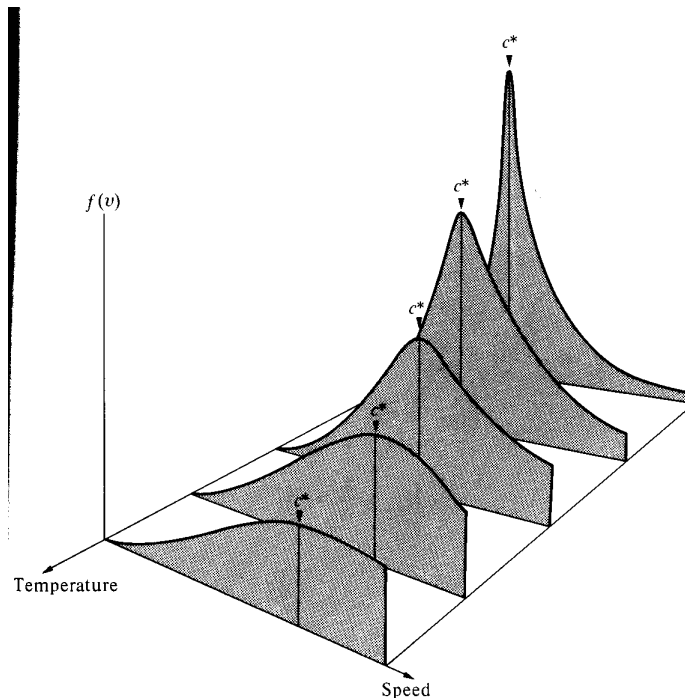

Gas Velocities

The **most probable speed** c^* is the speed corresponding to the maximum of the distribution:

$$c^* = \left(\frac{2KT}{m} \right)^{1/2}$$

The **mean speed** in contrast is the weighted speed

$$\bar{c} = \left(\frac{8KT}{\pi m} \right)^{1/2}$$

which again is slightly different from the **root mean square speed**

$$c = \left(\frac{3KT}{m} \right)^{1/2}$$

Speed depends on mass, typical values for mean speed at 25°C are

N_2 : 475 m/s

He : 1256 m/s

Escape Velocity

A moving body (in this case: a molecule) can leave the earth's gravitational field if its kinetic energy is larger than the potential energy needed to overcome the gravitational field. It depends only on altitude and at 500 km is of the order of 11 km s^{-1} .

If the speed of a molecule is high enough, and at the same time the mean free path is long enough, it may leave the atmosphere.

The speed depends on temperature and mass, the mean free path on density.

Typical values for mean free path are

200 km:	200m
100 km:	15 cm
0 km:	0.06 μm

Below 100 km (**Homosphere**), collisions between molecules are so frequent that all constituents are well mixed and no separation is possible. Above that altitude, the different scale heights come into effect (**Heterosphere**).

An example for the un-mixing is given in the figure

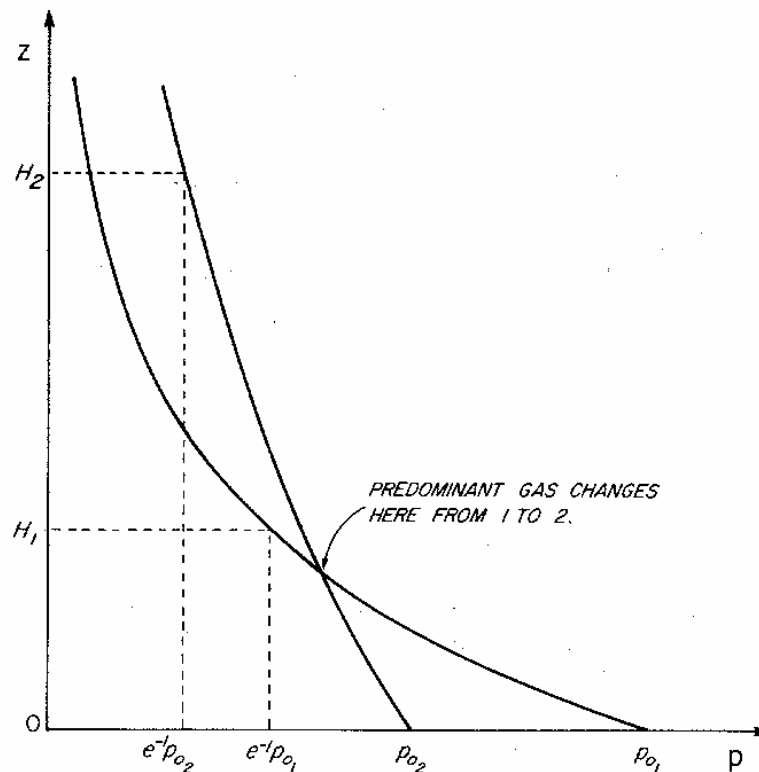

At the base of the escape region (**Exosphere**), temperatures are of the order of 600K. Thus, for atomic hydrogen, the most probable speed is about 3 km s^{-1} . From the Boltzmann distribution, a probability of about 10^{-6} exists for each collision that an atomic hydrogen is faster than 11 km s^{-1} and thus can escape the atmosphere. This explains the low atmospheric concentration of hydrogen. For O_2 , the probability is of the order of 10^{-84} , and thus escape is negligible.

Ionosphere

At high altitudes (> 60 km), the relative density of ions and electrons increases as a result of ionisation of air molecules by solar X-ray and UV radiation. High energy cosmic rays also contribute to ionisation. This layer is sometimes also called **Heaviside Layer**.

Ionisation increases with altitude as a result of

- increased mean free path \Rightarrow increased life time
- increased radiation

The free electrons in the Ionosphere have an impact on radio communication by reflecting or absorbing radio waves and also act as a Faraday cage against charged particles.

Charged particles are also produced in the atmosphere by other processes:

- radioactive decay of substances within the earth's crust
- charge separation within clouds

The free electrons make the ionosphere conducting, a so-called plasma. For a given electron density we can calculate the **plasma frequency** f , this results in the fact that the plasma becomes a reflector for all electromagnetic waves with frequencies $f < f_p$

$$f_p = \sqrt{N} \frac{e}{2\pi} \sqrt{\frac{1}{\varepsilon_0 m}} = \text{const} \sqrt{N}$$

with the $\text{const} \approx 9 \cdot 10^{-3}$, f_p in [MHz] and the electron density N in [cm^{-3}], m the mass of the electron and ε_0 the permittivity in vacuum.

Therefore for an electron density of $N = 3 \cdot 10^5 \text{ cm}^{-3}$ we find a plasma frequency $f_p \approx 5 \text{ MHz}$

Region	Altitude [km]	Electron density [cm^3] (typical, order of magnitude)
D	< 90	10^3 - 10^4
E	90 - 140	10^5
F ₁	> 140	Maximum of 10^6 in the region of 250 - 500 km
F ₂		

Layers in the Ionosphere

Three regions can be distinguished:

- D-layer (absorbing due to collisions with uncharged molecules)
- E-layer (density large enough that positive ions drift with the neutral constituents while electrons move along magnetic field lines and thus charges are separated, currents flow and voltages are induced)
- F-layer (long mean free path, structure determined by fields induced from E-region)

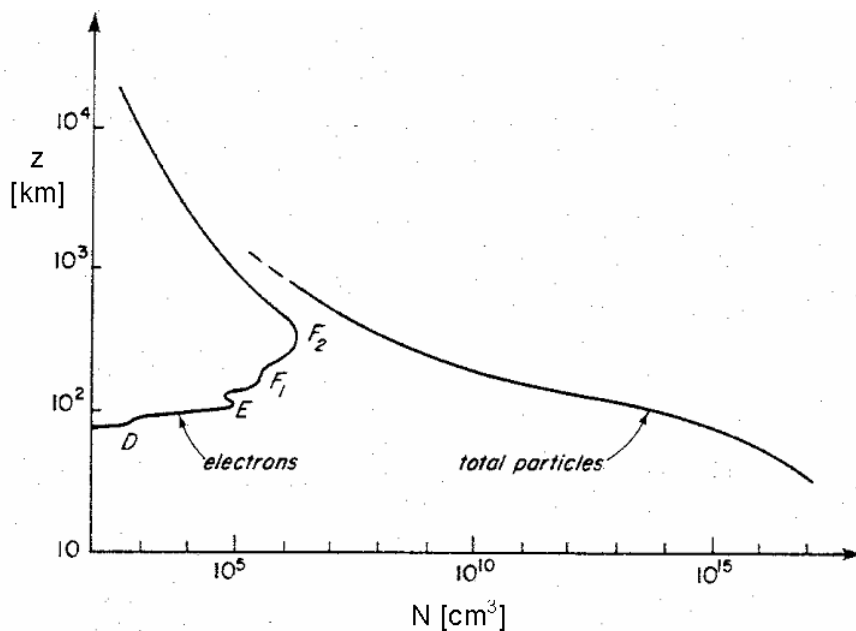

Diurnal cycle of the Ionosphere

At night, the electron density decreases, and the D-layer disappears. The F1 and F2-layers combine, and in the highest atmosphere the diurnal variation is small:

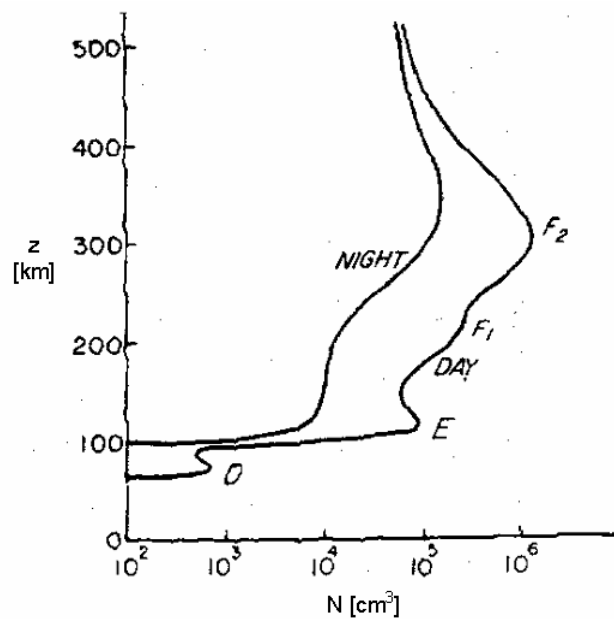

The absence of the absorbing D-layer has a large impact on radio communication that at night can suffer from reflections at the F-layer in the AM band whereas long range short wave communications work better at night.

The ionosphere also responds strongly to solar eruptions.

Extract from <http://www.spaceweather.com/>

What's Up in Space -- 29 Oct 2003

AURORAS NOW! The coronal mass ejection described below has reached Earth (at approximately 0630 UT on Oct. 29th) and triggered a strong geomagnetic storm. This storm is ongoing! Red and green Northern Lights have been spotted as far south as Bishop, California. *Stay tuned for updates.*

EXTREME SOLAR ACTIVITY: One of the [most powerful](#) solar flares in years erupted from giant sunspot 486 this morning at approximately 1110 UT. The blast measured X17 on the [Richter scale of solar flares](#). As a result of the explosion, a severe [S4-class](#) solar radiation storm is underway. [Click here](#) to learn how such storms can affect our planet. The explosion also hurled a coronal mass ejection (CME) toward Earth. When it left the sun, the cloud was traveling 2125 km/s (almost 5 million mph). This CME could trigger bright [auroras](#) when it sweeps past our planet perhaps as early as tonight.

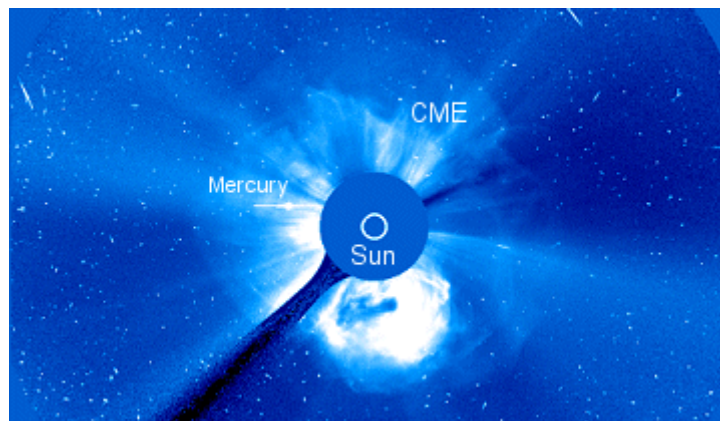

Above: This SOHO [coronagraph](#) image captured at 12:18 [UT](#) shows the coronal mass ejection of Oct. 28th billowing directly toward Earth. Such clouds are called [halo CMEs](#). The many speckles are solar protons striking the coronagraph's CCD camera. [See the complete movie.](#)

Where will the auroras appear? High-latitude sites such as New Zealand, Scandinavia, Alaska, Canada and US northern border states from Maine to Washington are favored, as usual, but auroras could descend to lower latitudes when the CME pictured above sweeps past Earth.

Right: Photographer [Lance Taylor](#) of Alberta, Canada, spotted these vivid Northern Lights on Oct. 21st. [\[gallery\]](#)

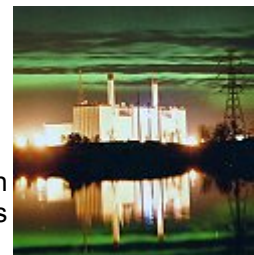

Not all CMEs trigger auroras. Several, for instance, have swept past Earth in recent days without causing widespread displays. It all depends on the orientation of tangled magnetic fields within the electrified cloud of gas. The incoming CME is no exception. It might cause auroras, or it might not. We will find out when it arrives.

Probing the Ionosphere

The electron density in the Ionosphere can be studied from the ground (and from space) by emitting radio signals at different frequencies and measuring the time lag of the reflected signal (Ionosonde):

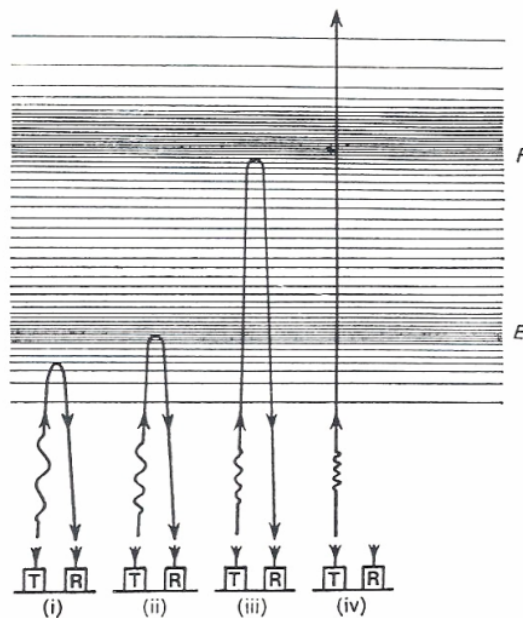

To reach higher altitudes, the frequency is increased. Absorption in the D-layer can not be studied in this way.

Magnetosphere

Above 500 km, collisions are infrequent and the magnetic field determines the motion of charged particles.

Earth's magnetic field is approximately a dipole with 11° inclination to the rotation axis.

Solar wind distorts the magnetic field:

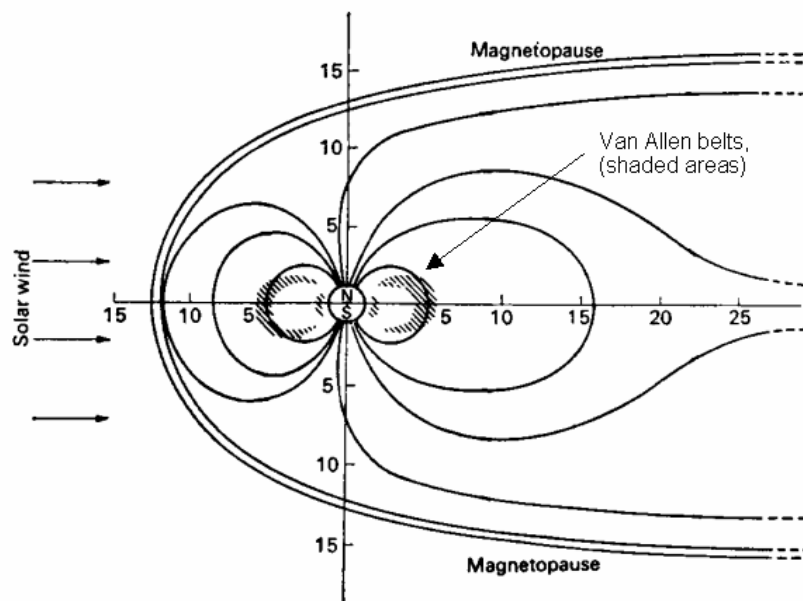

Solar outbursts impact the magnetic field and inject high energy particles into the lower ionosphere, which gives rise to brilliant auroral displays.

The magnetic field provides an important shield from solar wind.

Van Allen Belts

Charged particles that entered the magnetosphere experience a force perpendicular to their velocity and the magnetic field and travel around magnetic field lines from pole to pole (1s) and rotate around the earth:

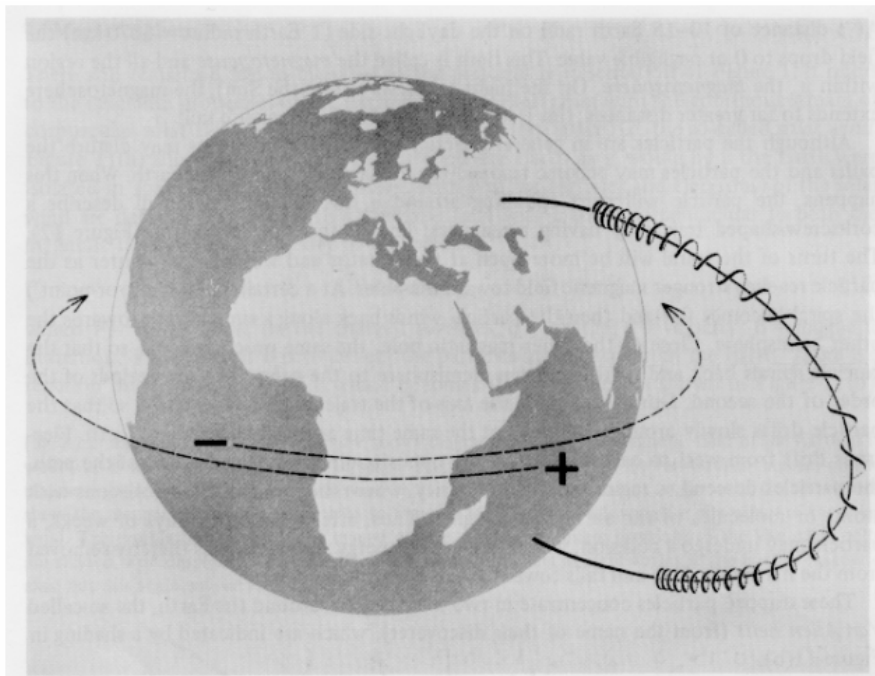

Close to the poles the particles can reach lower altitudes (80 - 150 km) where they can ionise air molecules which then emit light when recombining.

Aurora

Coloured lights in the sky at night in polar latitudes, mostly in an oval between 15° and 30° from the magnetic poles.

Aurora borealis = aurora in the Arctic

Aurora australis = aurora in the Antarctic

Source: Atomic and molecular emissions from oxygen and nitrogen caused by ionisation by fast charged particles in the ionosphere. The particles do not originate from the solar wind but are produced by it.

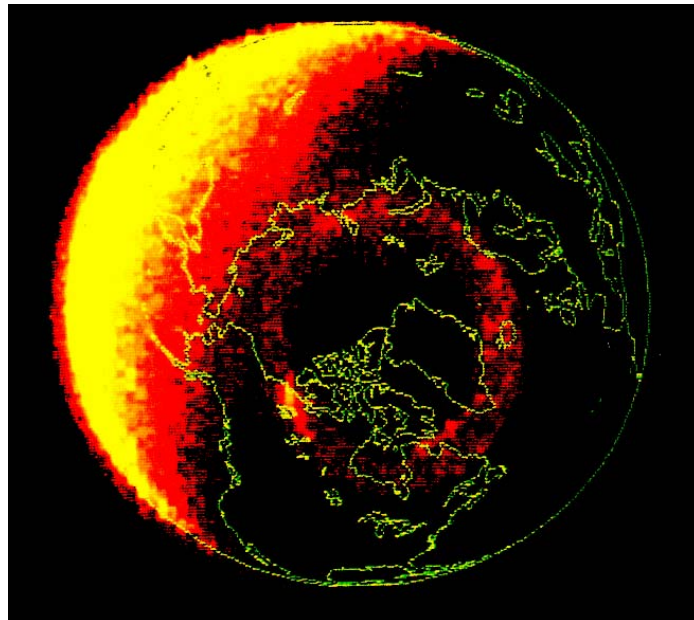

Earth in Space

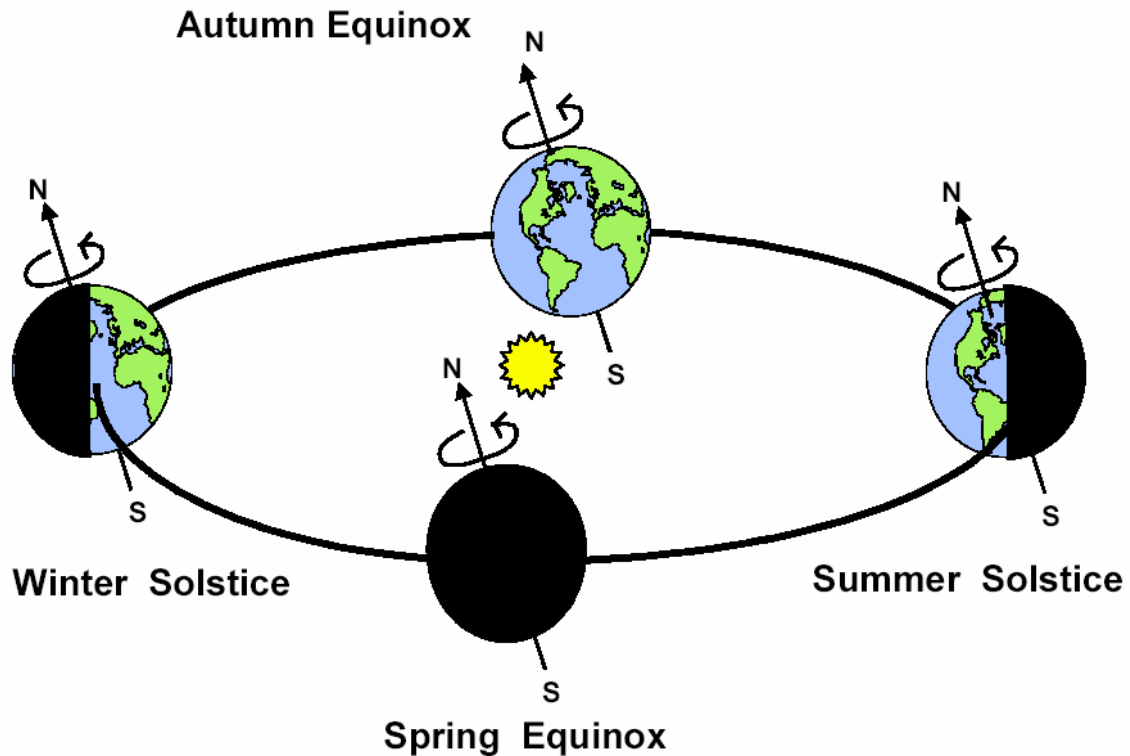

- Earth's orbit around the sun is slightly elliptic (149.6×10^6 km - 152×10^6 km)
- Earth's ecliptic is 23.5°
- seasons are result of ecliptic, not elliptic orbit
- during summer, there is polar day polewards of the arctic cycle, depending on date
- during winter, the pole is without solar illumination (polar night)
- twice per year, there is equinox (21.3. and 23.9.)

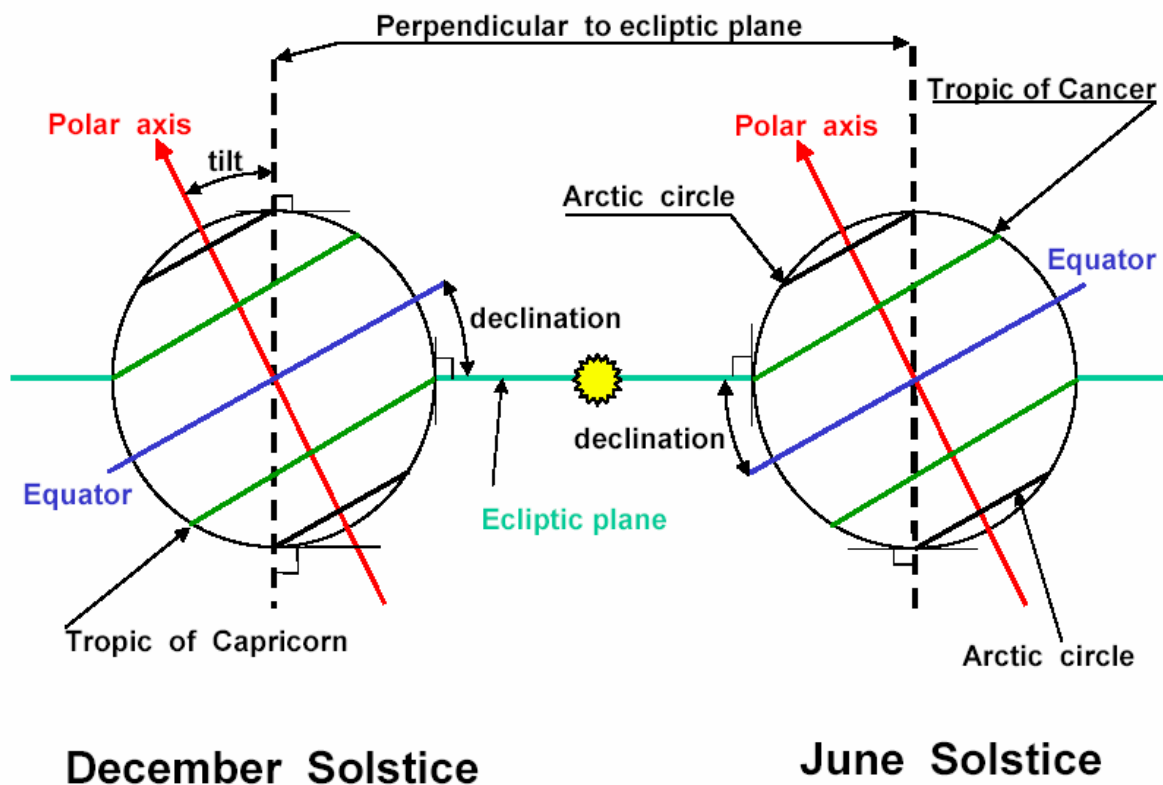

- in the **tropics**, the sun is in the zenith twice per year
- at **solstice**, the sun is in the zenith over the Tropic of Capricorn (December) or the Tropic of Cancer (June)
- day length varies slightly in the tropics but very much in high latitudes

The Electromagnetic Spectrum

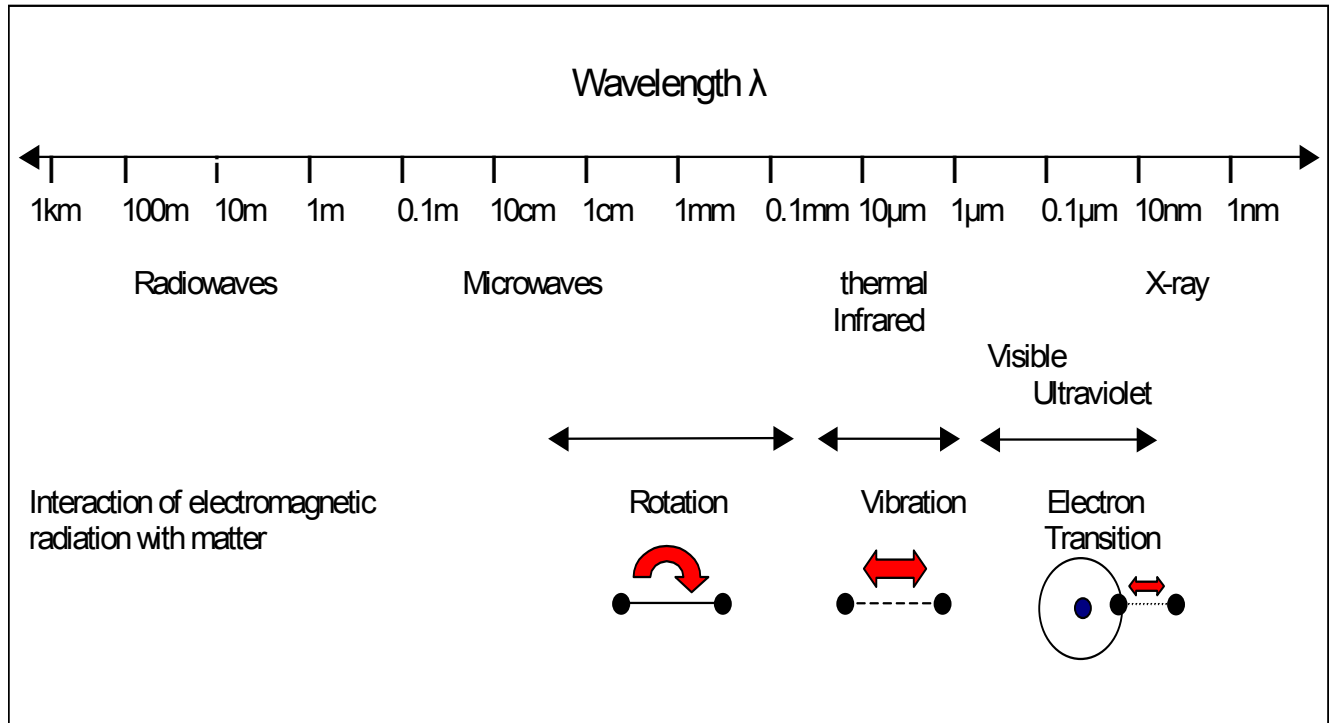

- nearly all energy on Earth is supplied by the sun through radiation
- wavelengths from many meters (radio waves) to nm (X-ray)
- small wavelength = high energy
- radiation interacts with atmosphere
 - absorption (heating, shielding)
 - excitation (energy input, chemical reactions)
 - re-emission (energy balance)
 - remote sensing applications

Radiation can be characterized by its **wavelength**, λ [m] and the **frequency** ν [Hz]. The two quantities are related by

$$\nu = \frac{c}{\lambda}$$

with $c = 2.9979250 \times 10^8$ m/s the speed of light

Sometimes (in particular in the IR), **wavenumber** k is used instead of frequency:

$$k = \frac{2\pi}{\lambda}$$

The energy of a photon is determined by the frequency:

$$E = h\nu$$

Name	Other commonly used names	Unit	Symbol
Radiant flux		W	P
Irradiance	Total Flux	Wm^{-2}	E
Radiance		$\text{Wm}^{-2}\text{sr}^{-1}$	I
Monochromatic Irradiance	Monochromatic Flux	$\text{Wm}^{-2}\text{m}^{-1}$	E_λ
Monochromatic Radiance	Monochromatic Intensity	$\text{Wm}^{-2}\text{m}^{-1}\text{sr}^{-1}$	I_λ

Radiometric Definitions:

Radiant energy Q_e

The energy carried by electromagnetic radiation

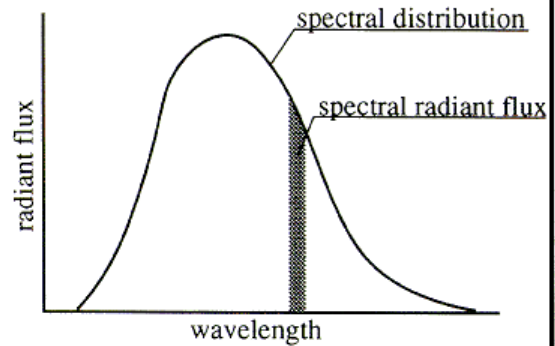

Radiant flux Φ

Radiant energy transmitted per unit time

Radiant intensity I_e

Radiant energy radiated from a point source per solid angle in a radial direction per unit time

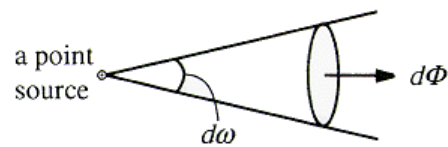

Irradiance E_e

Radiant energy incident upon a unit area per unit time

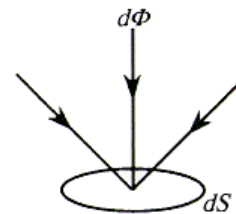

Radiant emittance M_e

Radiant energy radiated from a unit area per unit time

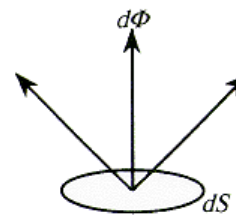

Radiance L_e

Radiant energy radiated from a unit projected area per unit solid angle in a radial direction per unit time

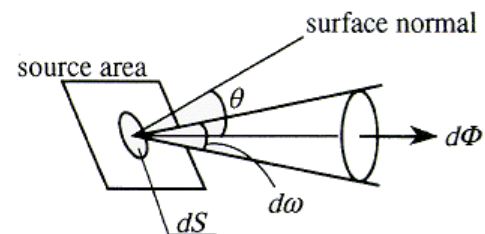

Black Body Radiation

A black body is a body or gas volume that

- has constant temperature
- absorbs all incoming radiation completely
- has the maximum possible emission in all directions and at all wavelengths

Planck's law:

$$E_{\lambda}(T) = \frac{2\pi hc^2}{\lambda^5 \left(\exp\left(\frac{hc}{kT\lambda}\right) - 1 \right)} \quad [Wm^{-2} m^{-1}]$$

E_{λ}	irradiance
h	Planck's constant
c	speed of light
λ	wavelength
k	Boltzmann's constant
T	temperature

Approximations:

Rayleigh-Jeans law (at long wavelengths)

Wien's law (short wavelengths)

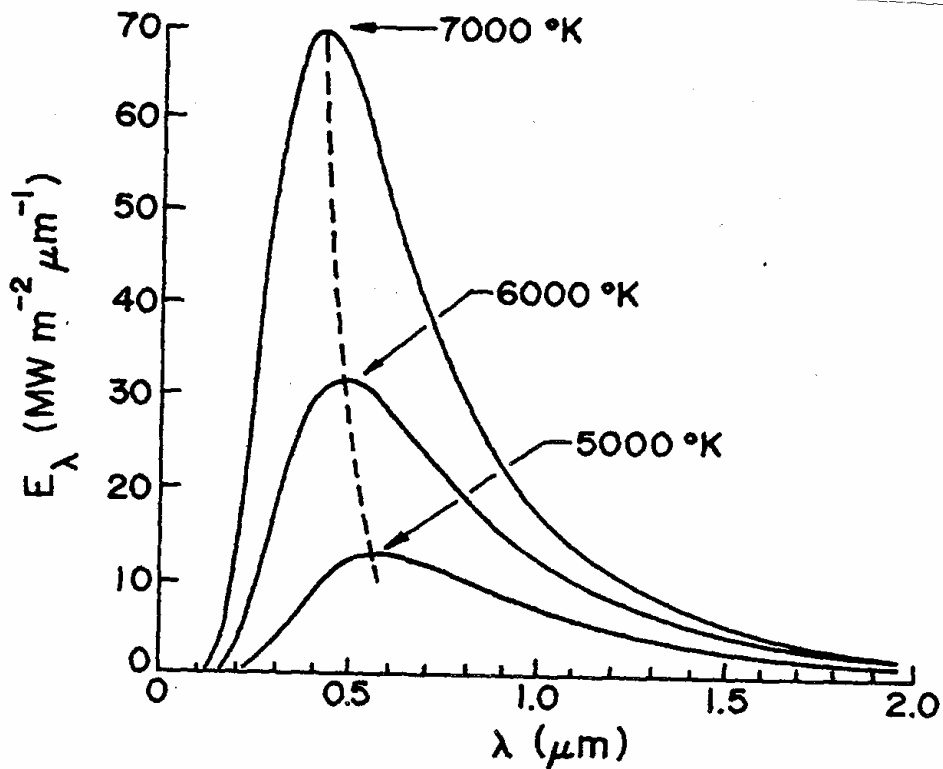

- large dependence on wavelength
- emitted power increases strongly with temperature
- curves from different temperatures do not cross each other
- total emitted power is the integral over all wavelengths

Wien's Law

The wavelength position of the maximum of the Planck curve depends on temperature:

$$\lambda_{\max} = \frac{b}{T}$$

b Wien's constant (2897 K μm)

i.e. the maximum of emission moves to shorter wavelengths with increasing temperature

Stefan-Boltzmann's Law

The total irradiance is the integral of the Planck emission over all wavelengths:

$$E = \sigma \varepsilon T^4$$

σ the Stefan-Boltzmann constant ($5.67 \times 10^{-8} \text{ W m}^{-2} \text{ K}^{-4}$)

ε emissivity

T Temperature

i.e.: The emitted power is proportional to the temperature to the 4th

Kirchhoff's Law

A body with wavelength independent emissivity < 1 is called **grey**.

absorptivity $\alpha(\lambda)$

emissivity $\varepsilon(\lambda)$

reflectivity $\rho(\lambda)$

transmissivity $\tau(\lambda)$

$$\alpha(\lambda) + \rho(\lambda) + \tau(\lambda) = 1$$

At the same wavelength, absorptivity and emissivity are identical:

$$\alpha(\lambda) = \varepsilon(\lambda)$$

The emission of a body is proportional to its emissivity:

$$E(\lambda) = \varepsilon(\lambda) E_{\text{black}}(\lambda)$$

If a body is black or white depends on wavelength
- snow e.g. is black in the IR! The best approximation for a black body is a cavity.

Proof of Kirchoff's Law

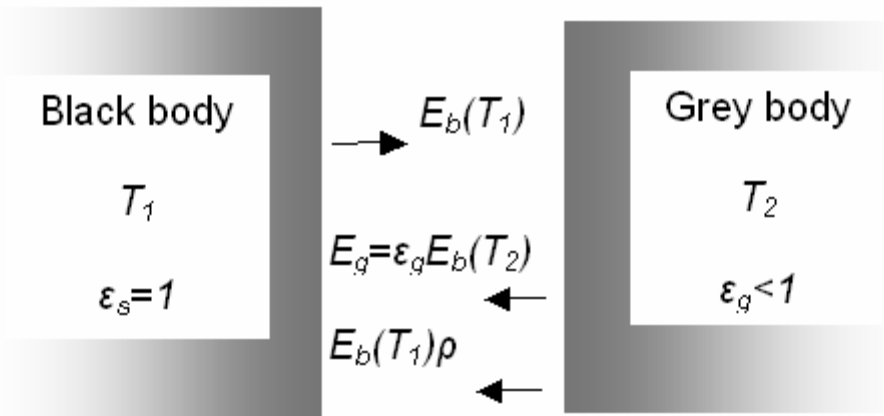

Idea: black body (T_1) and grey body ($\epsilon_g < 1$, T_2) are in radiative equilibrium

- emitted and absorbed irradiance must be identical i.e.:

$$E_b(T_1) * (1 - \rho) = E_g(T_2) = \epsilon_g E_b(T_2)$$
- in radiative equilibrium, the temperatures T_1 and T_2 must be the same as otherwise the second law of thermodynamics could be violated (energy flow from the colder to the warmer body)
- thus, $\alpha = (1 - \rho) = \epsilon$
- a similar argument can be used to establish identity at any wavelength:

$$\alpha(\lambda) = \epsilon(\lambda)$$

The Solar Spectrum

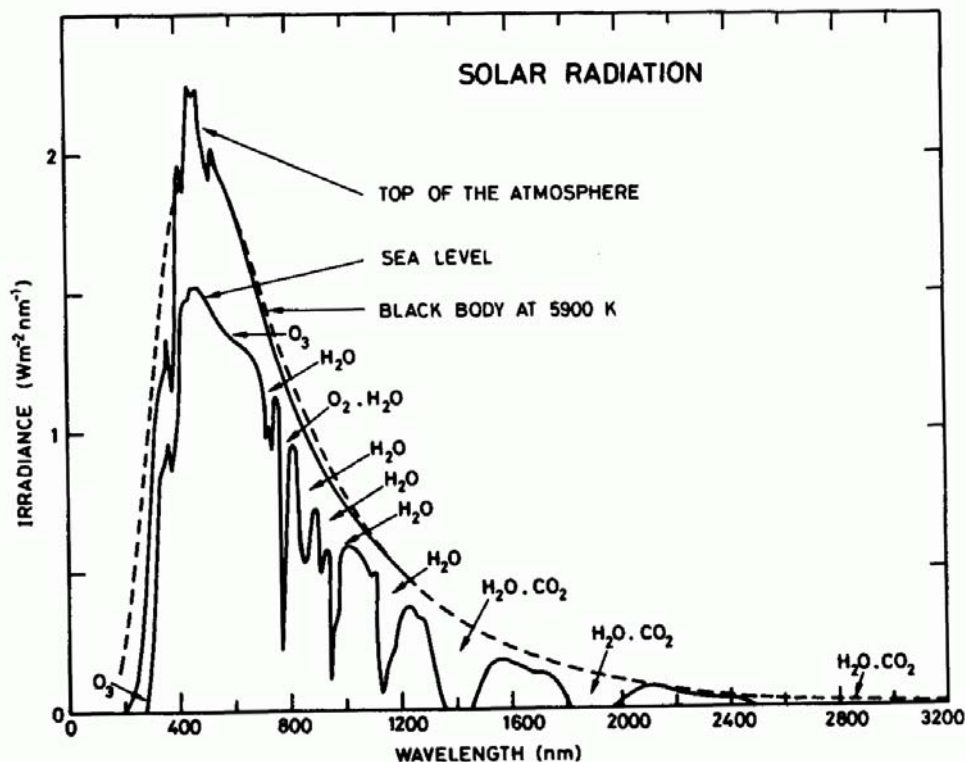
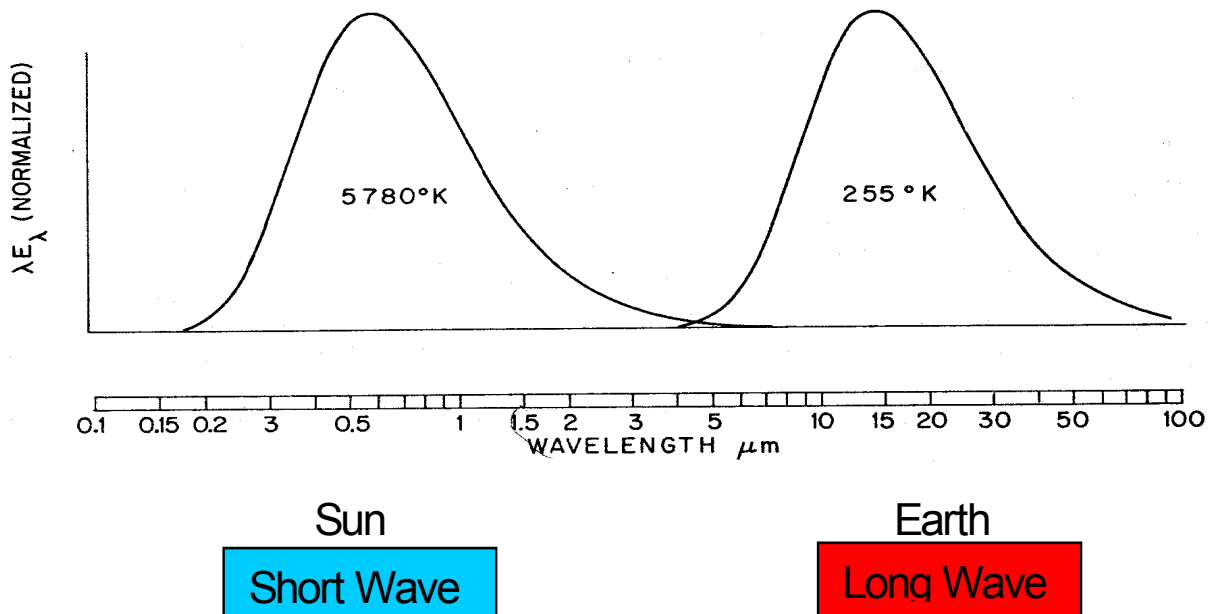

Fig. 4.6. Spectrum of solar radiation (UV, visible, IR) outside the earth's atmosphere and at sea level. (Adapted from Coulson, 1975).

- the solar spectrum can be approximated by a black body at temperature 5780K
- absorption in the solar atmosphere leads to Fraunhofer lines
- in the atmosphere, the solar radiation is attenuated by scattering and absorption
- strong absorption by O_3 , O_2 , H_2O und CO_2
- there are some atmospheric windows where absorption is small

Solar Spectrum and Earth Spectrum



- solar spectrum and earth spectrum have nearly no overlap
- **earth spectrum is not to scale, it is below the solar spectrum at all wavelengths!**

Planetary Equilibrium Temperatures

The radiant flux from the sun P can be computed from the irradiance:

$$P = A E = 4 \pi R_{\text{sun}}^2 \sigma T^4 = 3.84 \times 10^{26} \text{ W}$$
$$R_{\text{sun}} = 6.95 \times 10^8 \text{ m}$$
$$T_{\text{sun}} = 5780 \text{ K}$$

In the distance earth has from the sun, the solar irradiance is called the **solar constant** F_{earth}

$$F_{\text{earth}} = P_{\text{sun}} / A_{\text{sphere}} = P_{\text{sun}} / 4 \pi R_{\text{earth-sun}}^2 = 1376 \text{ W m}^{-2}$$

$$R_{\text{earth-sun}} = 1.49 \times 10^{11} \text{ m}$$

For a planet in arbitrary distance, the radiant flux P received is

$$P = \pi r^2 (1 - \rho) \frac{F}{R^2}$$

P : solar radiant flux absorbed by the planet

r : radius of planet

ρ : reflectivity or albedo of the planet

R : distance of the planet from the sun, normalized to the sun-earth distance = 1

F_{Earth} : solar constant

Assuming radiative equilibrium, the energy received by the sun must be balanced by the thermal emission I of the planet:

$$I = 4\pi r^2 \sigma T^4$$

(Note that radiation is emitted in all directions but received only by the area illuminated by the sun). Solving for the equilibrium temperature yields the following values:

Planet	Calculated Temperature [K]	Measured Temperature [K]
Venus	227	230
Earth	255	250
Mars	216	220
Jupiter	98	130

Here, the measured temperature is the apparent temperature as seen from space, not the surface temperature.

Radiative Transfer in the Atmosphere

Contributions:

- Direct Solar Ray
- Reflection on the Surface
- Reflection from Clouds
- Scattering in the Atmosphere
 - Rayleigh Scattering
 - Mie Scattering
 - Raman Scattering
- Absorption in the Atmosphere
- Emission in the Atmosphere
- Emission from the Surface
- Emission from Clouds

Absorption in the Atmosphere

Absorption in a volume is proportional to

- I_0 initial radiance
- ds light path
- n number density of absorbers [m^{-3}]
- $\sigma_a(\lambda)$ **absorption cross-section** [m^2]

$$dI = - I_0 \sigma_a(\lambda) n ds$$

$k_a = n \sigma_a$ is the **absorption coefficient** [m^{-1}]

Integration along the light path leads to **Lambert Beer's law**:

$$I(s) = I(0) \exp\left(-\int_0^s k_a(s') ds'\right)$$

and for a homogeneous atmosphere

$$I(s) = I_0 \exp(-k_a s)$$

The integrated absorption is called **Opacity** or **Optical Depth** τ :

$$\tau(s) = \int_0^s k_a(s) ds$$

The transmissivity $t(s)$ is

$$t(s) = \frac{I(s)}{I(0)} = \exp(-\tau(s))$$

and the absorptivity $a(s)$

$$t + a = 1$$

$$a(s) = 1 - t(s)$$

for an opacity $\tau \rightarrow \infty$ the absorptivity $a \rightarrow 1$, this is called the optically “thick” case.

Note: σ_a , τ , t and a can be functions of the wavelength λ .

Scattering in the Atmosphere

If a photon is absorbed and then immediately re-emitted we have scattering. Mechanisms of Scattering are:

- **Rayleigh**-Scattering
- **Mie**-Scattering
- Geometric Optics
- (Inelastic Raman-Scattering)

Usually, scattered photons have the same wavelength (elastic scattering) but not the same direction as the original photon.

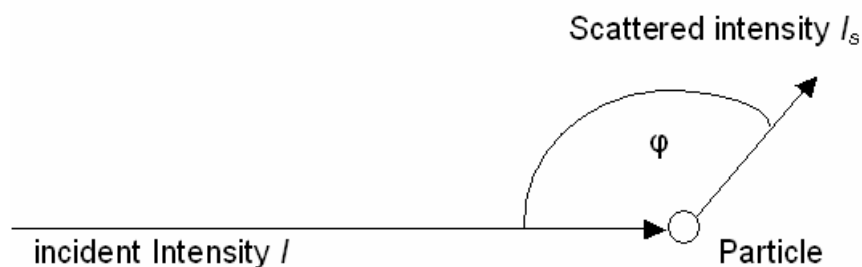

The **phase function** $P(\varphi)$ gives the distribution of scattered intensity as a function of scattering angle; the integral over all wavelengths is 1.

Scattering can be both a sink and a source of radiation:

The loss by scattering is treated in analogy to absorption with a scattering cross-section σ_s :

$$dI = - I_0 \sigma_s(\lambda) n ds$$

The loss by absorption and scattering is often combined and called **extinction**:

$$k_e = k_a + k_s$$

The amount of radiation gained by scattering is given by the amount of light coming from a given direction multiplied by the scattering probability into the direction of interest integrated over all possible directions:

$$\frac{dI}{ds} = k_s \frac{1}{4\pi} \int_{4\pi} I(\omega') P(\omega, \omega') d\omega'$$

where $P(\omega, \omega')$ is again the phase function.

Depending on the ratio of the size of the scattering particle (r) to the wavelength (λ) of the light:

Mie parameter $\alpha = 2\pi r / \lambda,$

different regimes of atmospheric scattering can be distinguished:

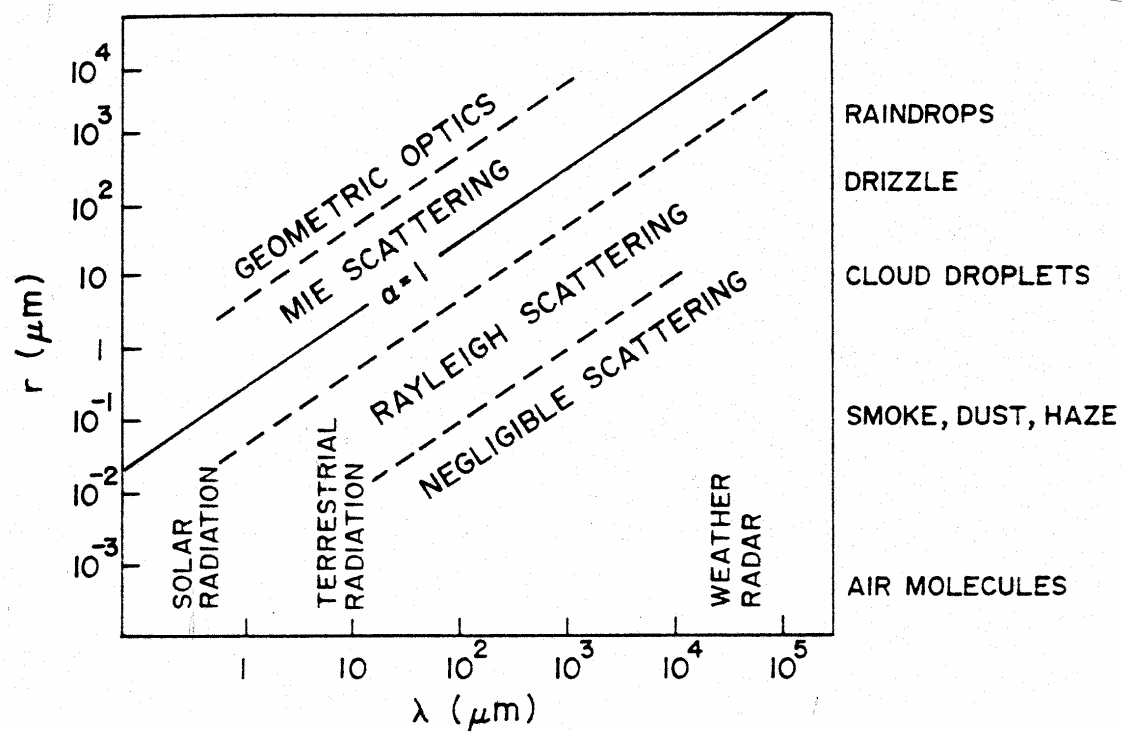

Treatment of scattering: in analogy to absorption, however with a scattering coefficient

Rayleigh Scattering

- Scattering at „small“ particles (molecules)
- displacement of charges in the electromagnetic field
- particles themselves radiate as dipoles
- wavelength of incoming and outgoing radiation is the same
- angular distribution is changed
- effectiveness of Rayleigh scattering varies with λ^{-4}
- scattering coefficient is proportional to the square of the refractive index
- intensity of scattered radiation is proportional to $1 + \cos^2 \Theta$ (Θ is scattering angle) if incoming light is unpolarized

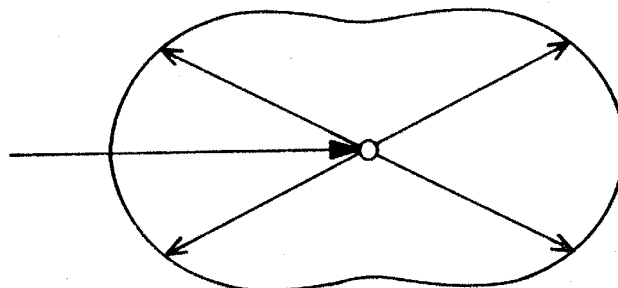

Rayleigh phase function

- light is mainly scattered in the forward or backward direction
- Rayleigh scattered light is strongly polarised for 90° scattering angle

Rayleigh scattering can be explained in terms of an ensemble of dipole emitters. A more accurate treatment has to be based on density fluctuations in the scattering medium.

Geometry for Rayleigh Scattering



Abb. 1.16. Polardiagramm der Rayleigh-Streuung für die beiden Polarisationsrichtungen E-Feld in der Streuebene (oben) und E-Feld senkrecht zur Streuebene (unten). Als Streuebene ist jeweils die Zeichenebene anzusehen

- the atmosphere appears blue as short wavelengths are scattered more efficiently
- UV radiation usually is scattered before reaching the surface
- skylight is polarised perpendicular to the plane formed by the sun, the observer and the scattering molecule
- the maximum of polarisation is reached at 90° scattering angle

Mie Scattering

- scattering on „large“ particles (aerosols, droplets, suspended matter in liquids)
- explained by coherent scattering from many individual particles
- for spherical particles, Mie scattering can be computed from the refractive index using the Maxwell equations
- wavelength of incoming radiation is not changed
- angular distribution is changed

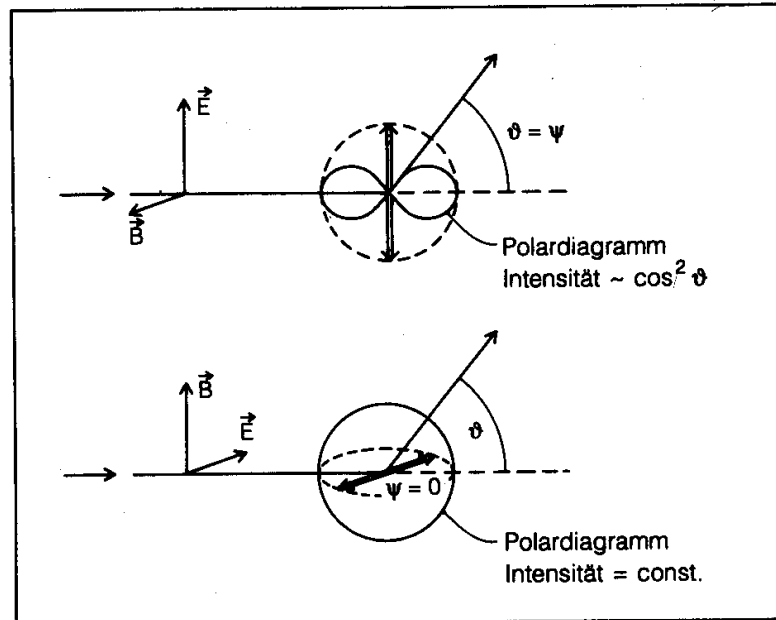
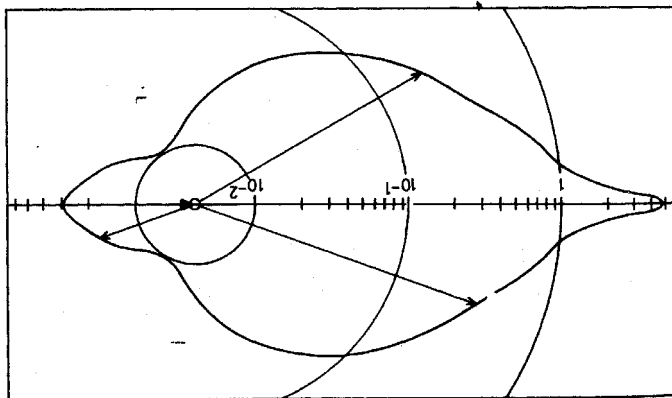

Mie phase function for typical cloud droplet size distribution

- depending on α , forward scattering is strongly favoured
- effectiveness of Mie scattering is proportional to λ^{-1} to $\lambda^{-1.5}$
- in general. Mie scattering is not polarising

Phase function for Mie Scattering

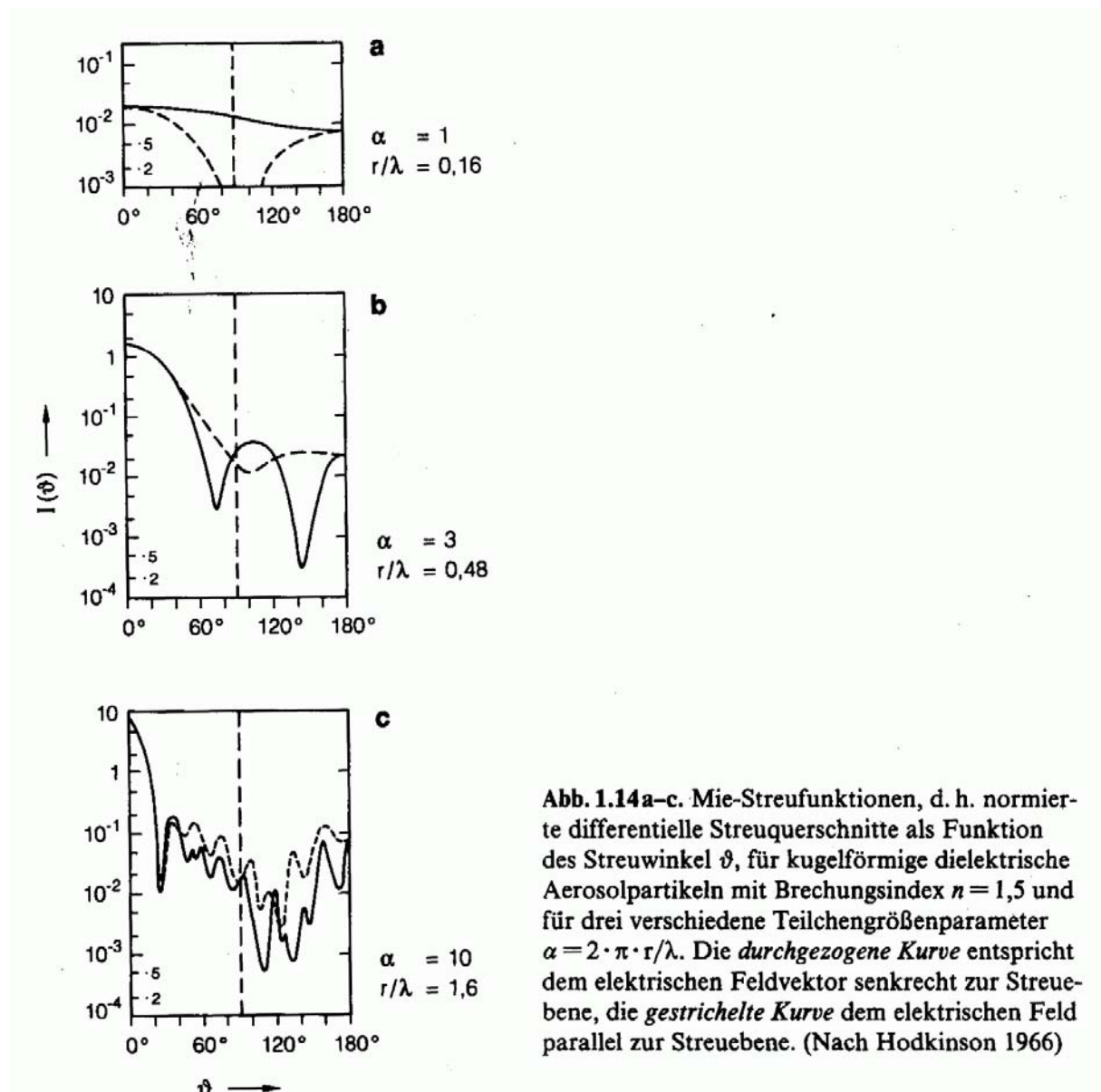

- angular distribution is a complex function of particle size even for spherical particles
- the larger the particles, the stronger the forward scattering peak
- Mie scattering leads to „whitening“

Extinction by Mie Scattering

Abb. 1.15. Mie-Extinktionsfunktionen E , d. h. auf den Partikelquerschnitt normierte Extinktionsquerschnitte, als Funktion des Teilchengrößenparameters $\alpha = 2 \cdot \pi \cdot r / \lambda$, für zwei verschiedene Brechungsindizes n des Teilchenmaterials. (Nach Hodgkinson 1966) Für sehr große α konvergiert $E(\alpha)$ gegen 2; zur Begründung siehe z. B. Van de Hulst (1981)

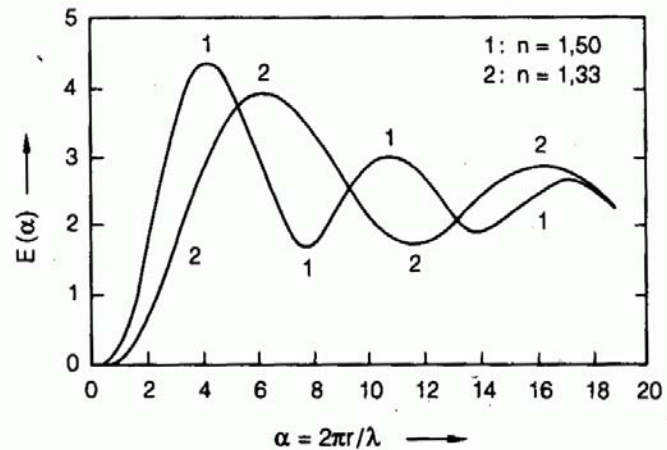

In general, Mie scattering can not be treated quantitatively as

- most particles are not spherical
- the composition of particles is in general not known
- the size distribution of particles is in general not known
- changes in humidity can have a strong impact on the optical properties
- absorption in aerosols can in general not be neglected

Geometric Optics

When the wavelength is much smaller than the particle dimension ($\alpha \gg 1$) geometric optics apply. This situation is not very important in the atmosphere, but can lead to nice visual effects such as the rainbow.

Rainbows are created by the refraction of light in water droplets. Three rainbows exist: One at 41° around the point opposite of the sun, a second, inverted one with 51° and a third one with a radius of 140° in the direction of the sun.

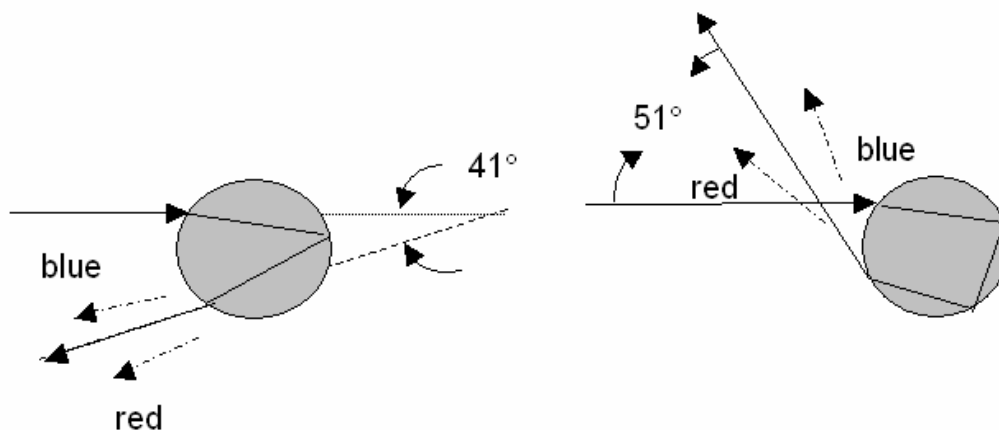

Geometrical considerations lead to the critical angles, at which light is concentrated and thus a bright rainbow is visible.

A similar effect is created by ice crystals and called **Halo:**

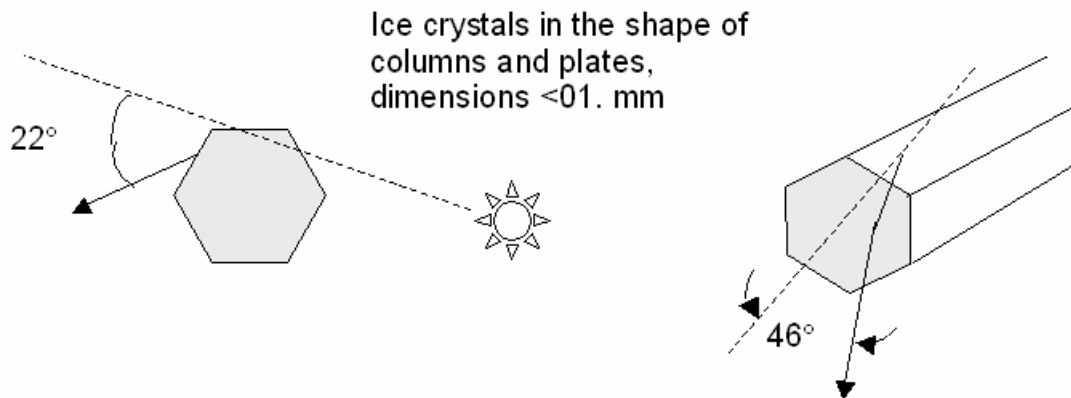

Scattering / Reflection on the Surface

- **Lambertian albedo**

the reflected intensity does not depend on the viewing angle:

$$J = J_0 \cos(\vartheta)$$



Abb. 11.6. Lichtstärke einer Fläche nach dem Lambertschen Kosinusetz

Example: paper

counter example: liquid crystal display

- Spectral albedo

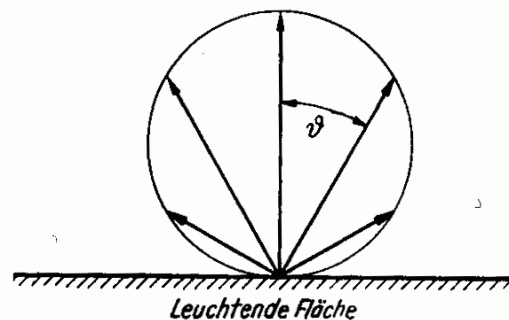
In most cases, albedo is a function of wavelength (water is blue, sand is yellow)

- Geometric reflections

from direct sunlight, for example on water or ice

- Sea glint

contributions from geometric reflection on rough surfaces

- Planetary albedo: the average ratio of reflected light from Planet Earth including clouds (30%)

Emission in the Atmosphere

At wavelengths $> 4\mu\text{m}$ thermal emission in the atmosphere becomes important.

- emission follows **Planck's law**
- local temperature determines emission strength if **Local Thermal Equilibrium** (LTE) can be assumed (enough collisions for Boltzmann statistics to apply for state function)
- according to **Kirchhoff's law**, emission occurs at wavelengths where atmospheric gases have absorption bands

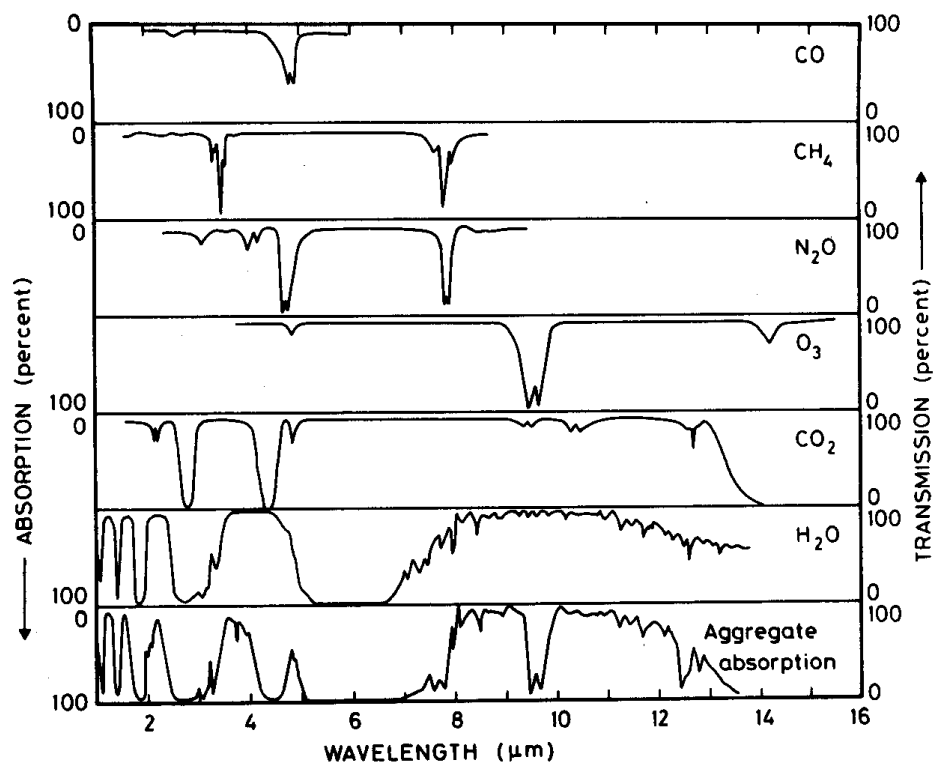

Radiative Transfer Equation

The change in intensity for radiation propagating through a medium is given by

$$\frac{dI}{ds} = -\underbrace{(k_a + k_s)}_{\text{extinction}} I + \underbrace{\alpha B(T)}_{\text{thermal source}} + \underbrace{\frac{1}{2\pi} \int_{4\pi} I(\omega') P(\omega, \omega') d\omega'}_{\text{scattering source}}$$

where

- all quantities depend on wavelength
- k_a , k_s , α and P depend on the composition of the medium
- $B(T)$ and also k_a depend on temperature

Absorption:

Assumptions: no scattering, no refraction, plane parallel

Then, absorption is proportional to the number density of molecules:

$$da_{\lambda} = -\frac{dE_{\lambda}}{E_{\lambda}} = -\beta_{\lambda} \rho \sec \theta dz$$

E_{λ} the irradiance

da_{λ} the incremental absorption

β_{λ} the mass absorption cross-section in [m^2/kg]

ρ the density in [kg/m^3].

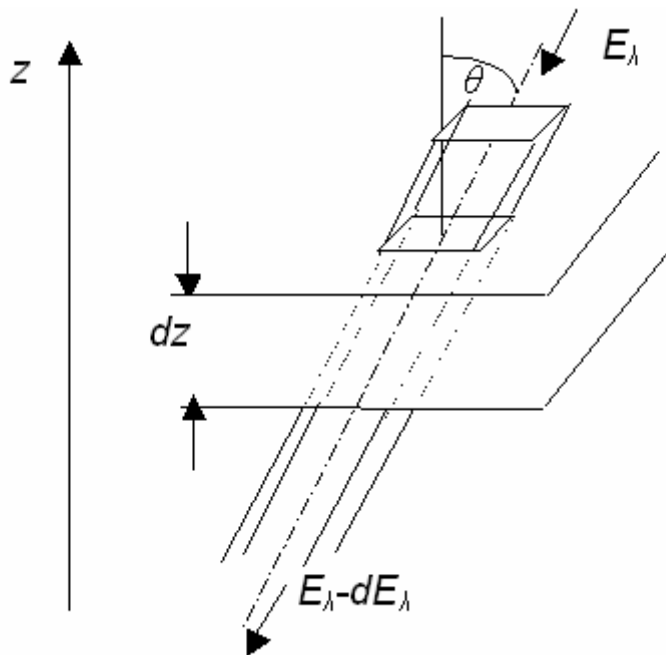

Integrating from altitude z to infinity

$$\ln E_{\lambda,\infty} - \ln E_{\lambda} = \sec \theta \int_z^{\infty} \beta_{\lambda} \rho \, dz$$

$$E_{\lambda} = E_{\lambda,\infty} \exp(-\tau_{\lambda}) \quad \text{with} \quad \tau_{\lambda} = \left(\int_z^{\infty} \beta_{\lambda} \rho \, dz \right) \sec \theta$$

The transmissivity and absorptivity of a gas layer are given by

$$t_{\lambda} = \frac{E_{\lambda}}{E_{\lambda,\infty}} = \exp(-\tau_{\lambda}) ; \quad a_{\lambda} = 1 - t_{\lambda}$$

The relation between absorption and optical depth can be linearized for small absorptions ($a_{\lambda} \approx \tau_{\lambda}$) but becomes highly nonlinear at large absorptions:

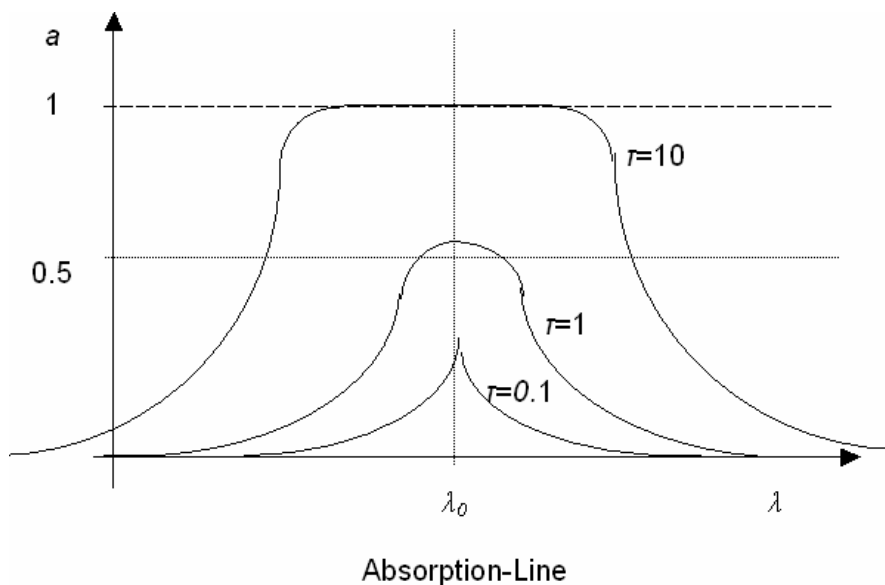

Where is most radiation absorbed?

At high altitudes, the intensity is large, but the number of absorbers / scatterers small. At low altitudes, the opposite is true. In between the change in radiation has a maximum, roughly at an opacity of 1.

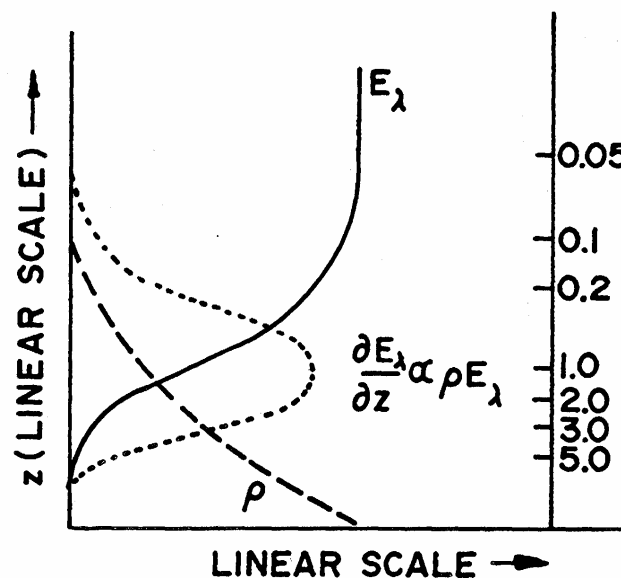

This can also be shown quantitatively (see Wallace and Hobbs or the Script by Künzi and Buehler).

Absorption and Emission

At large wavelengths, emission can no longer be neglected, and absorption and emission have to be treated in parallel.

While solar radiation can be treated as a parallel beam, and irradiances could be used, emission is diffuse and integration over radiance in all angles becomes necessary. For simplicity we only treat the upwards and downwards flux here and assume satellite nadir view:

Amount of radiation emitted from the surface $I_{\lambda,S}$ and absorbed by the atmospheric layer dz :

$$-dl_{\lambda,S} = I_{\lambda,S} \beta_{\lambda} \rho \sec \theta dz$$

Corresponding emission (Kirchoff's law):

$$dl_{\lambda,A} = B_{\lambda} \beta_{\lambda} \rho \sec \theta dz$$

The total change in radiation is the sum of emission and absorption:

$$dl_{\lambda} = dl_{\lambda,A} + dl_{\lambda,S}$$

Which leads to the **Schwarzchild equation**:

$$dl_{\lambda} = \beta_{\lambda} \rho (B_{\lambda} - I_{\lambda,S}) dz$$

where $\Theta = 0^{\circ}$ (zenith)

When looking at the atmosphere from space, the total radiance from surface and atmosphere is (neglecting scattering):

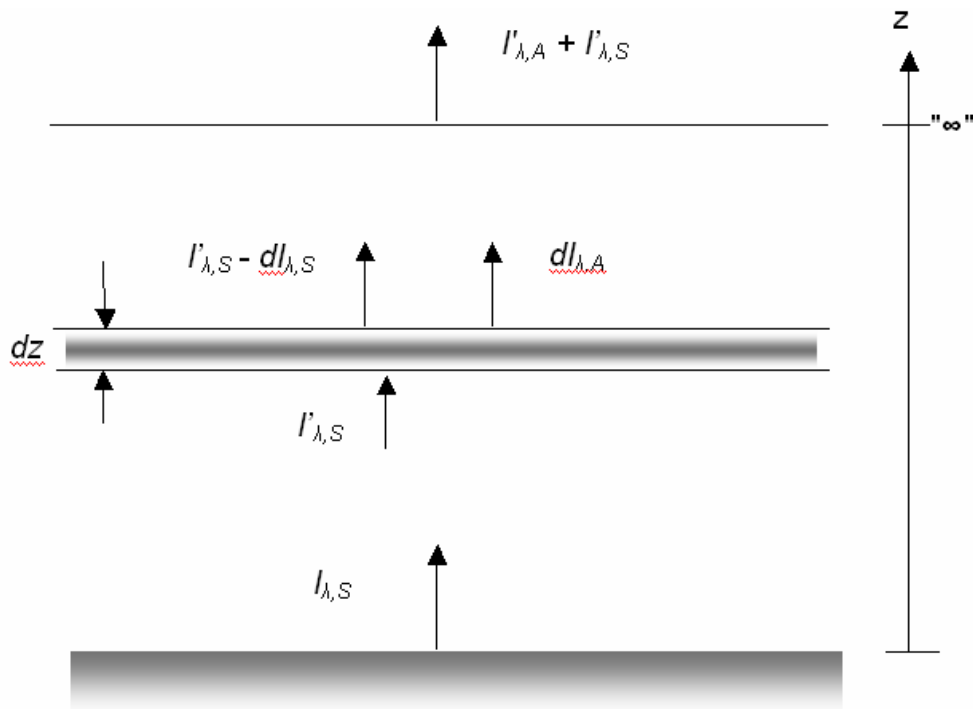

One layer in the atmosphere:

Surface:

$$I'_{\lambda,S} = I_{\lambda,S} \exp\left(-\int_0^{\infty} \beta_{\lambda} \rho dz\right) = I_{\lambda,S} \exp(-\tau_0)$$

Total Radiance at top of atmosphere:

$$I_{Total} = I_{\lambda,S} \exp(-\tau_0) + \int_0^{\infty} \beta_{\lambda} \rho B_{\lambda} \exp(-\tau) dz$$

Satellite measurements of temperature

Idea: For a well mixed absorber (O_2 , CO_2) the β_λ is independent of altitude, and the only height dependency is from the known vertical density profile and the Planck emission, which depends on temperature.

$$\text{Density: } \rho(z) = \rho_0 \exp\left(-\frac{z}{H}\right)$$

If the surface term can be neglected (optically thick atmosphere), the radiance at top of atmosphere is

$$I_{\lambda,A,total} = \rho_0 \int_0^\infty \beta_\lambda B_\lambda(z) \exp\left(-\frac{z}{H}\right) \exp\left(-\rho_0 \int_z^\infty \beta_\lambda \left(-\frac{z'}{H}\right) dz'\right) dz$$

It is convenient to combine all terms with the exception of B_λ in the **Weighting Function** $W(\lambda, z)$, leading to

$$I_{\lambda,A,total} = \int_0^\infty W(\lambda, z) B_\lambda(z) dz$$

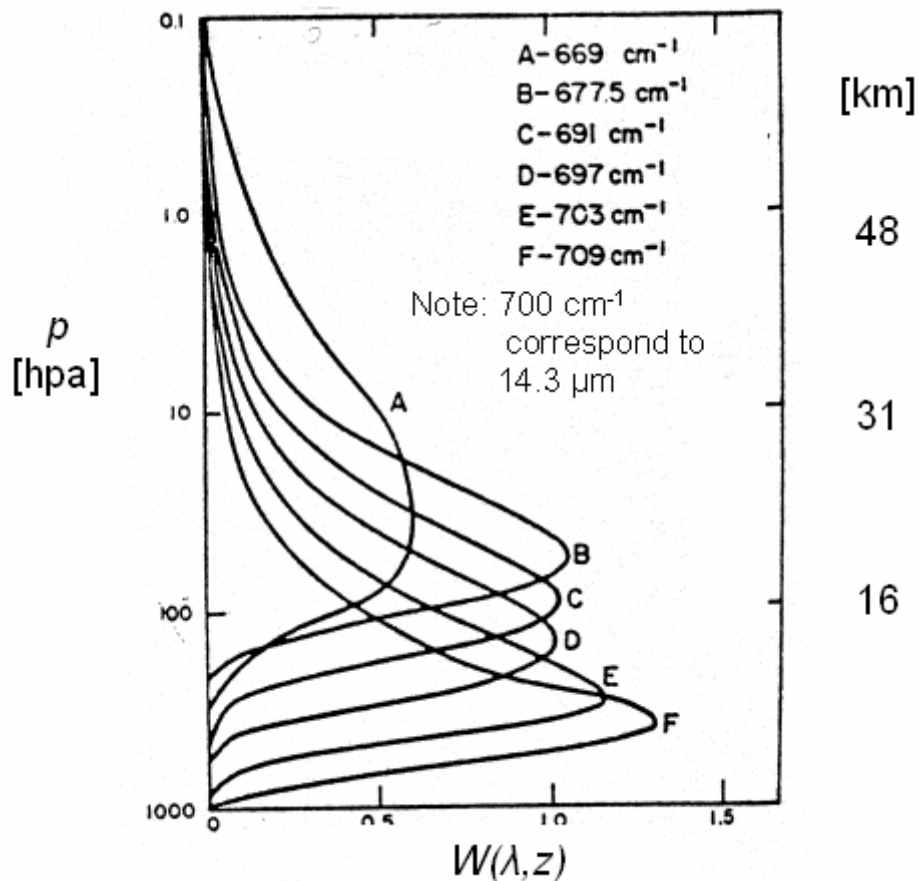

Weighting functions for a nadir looking space borne sensor observing thermal radiation emitted by CO_2 near the strong 15 μm band.

- different wavelengths have peak contributions from different altitudes
- the latitude depends on the absorption - larger absorption leads to higher peak
- deduction of temperature profile necessitates “inversion”

If the temperature distribution is known, a vertical absorber profile can be retrieved!

Selective Absorbers / Emitters

- A black body absorbs at all wavelengths with maximum efficiency ($\alpha = 1$)
- A grey body has a wavelength independent absorptivity of $\alpha < 1$
- A **selective absorber** has a wavelength dependent absorptivity $\alpha(\lambda)$

All relevant absorbers in the atmosphere on the surface are selective (coloured). Most important for the atmospheric radiation budget: absorbers that have different absorptivity in the short wave and long wave region.

If a surface has large absorptivity at short wavelengths (where energy from the sun is abundant) and a small absorptivity at long wavelengths (where energy is lost through radiation), it will become warmer than a black body. If the opposite is true (e.g. snow), it will become colder than a black body.

The atmosphere acts as an selective absorber, as absorption by trace species is large in the IR but small in the visible:

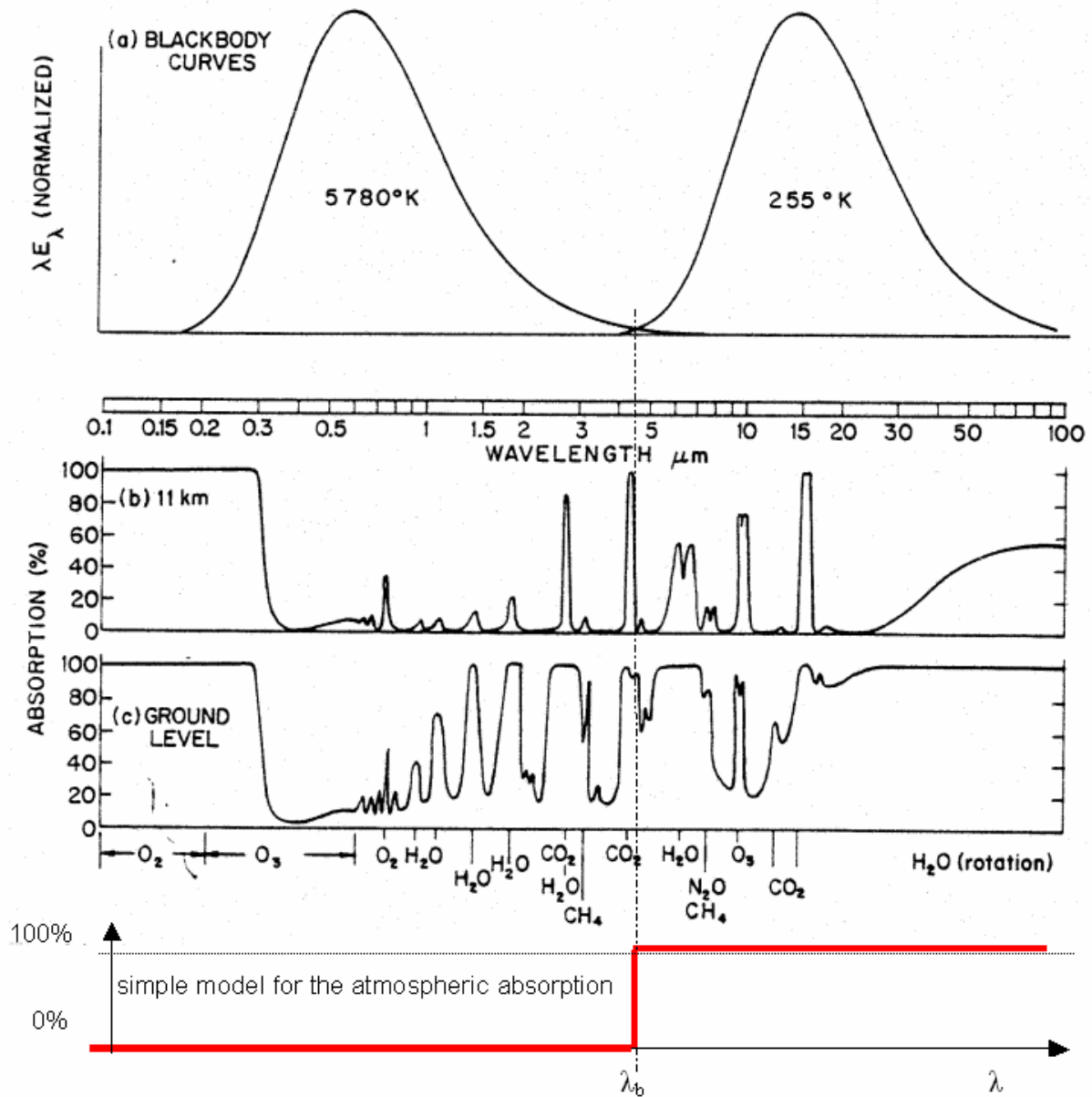

In the IR, the atmosphere is opaque with the exception of two small atmospheric windows at $8\mu\text{m}$ and $12\mu\text{m}$.

Greenhouse Effect

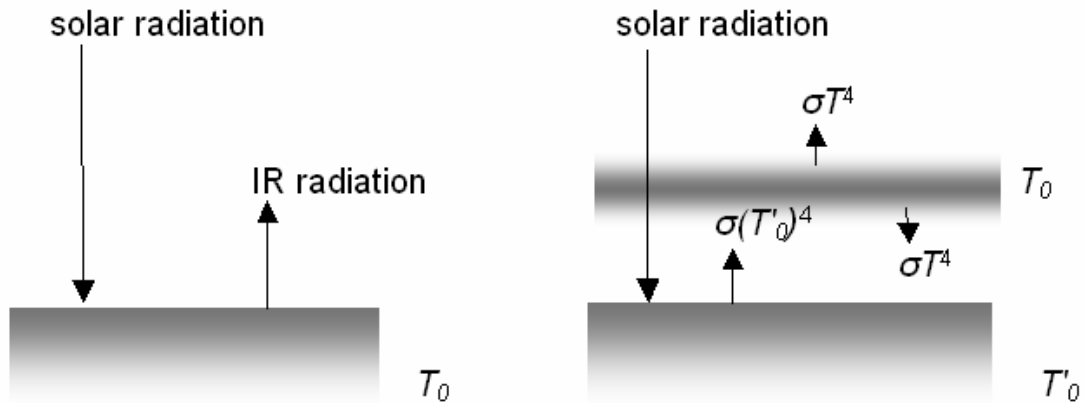

With an atmosphere with large IR absorption, the surface receives the solar short wave radiation plus the IR counterradiation, and thus in radiative equilibrium is at higher temperature than without atmosphere.

A rough estimate yields:

$$E = \sigma T_0^4$$

$$2\sigma T_0^4 = \sigma(T'_0)^4$$

$$T'_0 = \sqrt[4]{2} T_0 \approx 1.2 T_0$$

or an increase from 285K => 300 K.

Note that agricultural greenhouse mainly works by reducing heat loss through convection and advection.

Example: Atmospheric emission spectra from Mars and Earth:

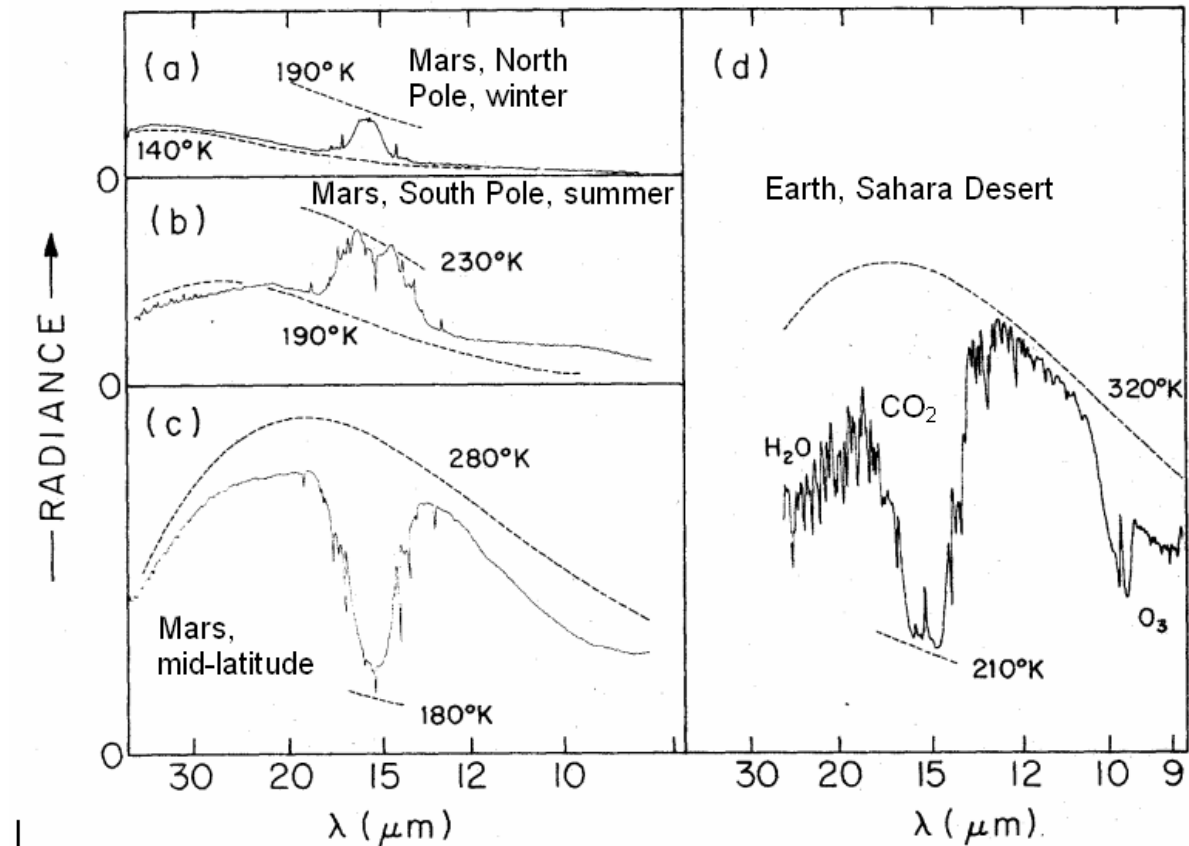

- in the cold polar regions, the atmosphere on Mars appears warmer than the cold surface
- in mid-latitudes, the opposite is true
- in Earth's atmosphere, emissions from O_3 and H_2O are also evident

The Global Energy Budget

Short wave radiation:

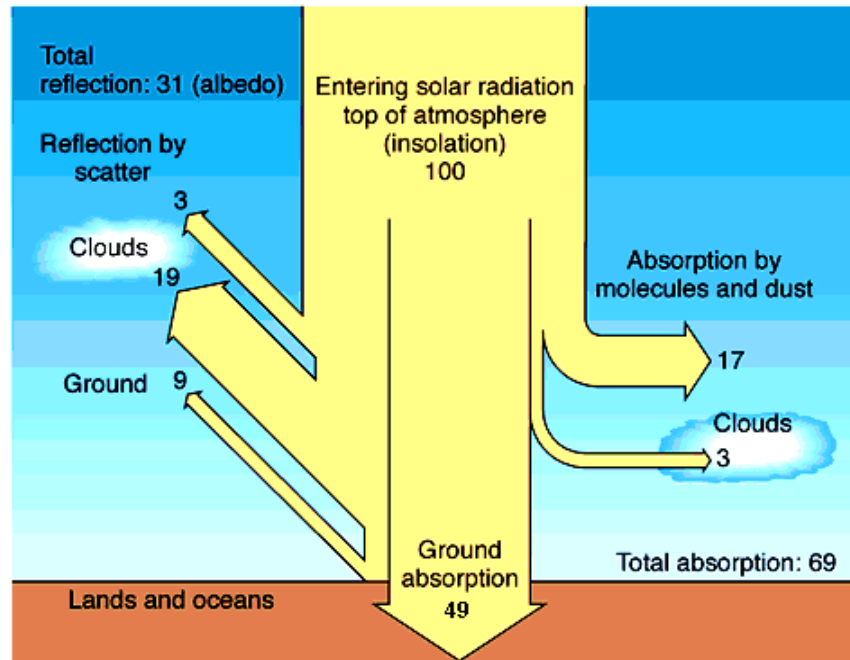

© John Wiley & Sons, Inc.

Long wave radiation:

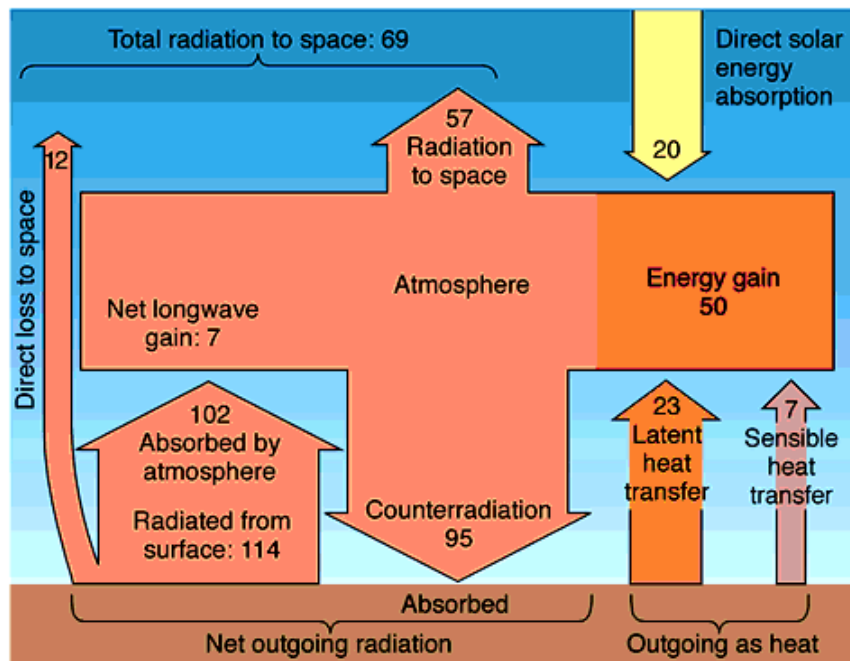

© John Wiley & Sons, Inc.

All other energy inputs into the system are small in comparison:

process	[W/m ²]
cosmic radiation	0.01
fossil fuels and nuclear energy	0.02
Geothermal energy	0.06
Heat storage in the ocean for a temperature increase of 0.3 K/century	0.2
Energy required for a complete melting of ice sheets in 1000 years	0.6

Thus, over longer time periods, earth is in radiative equilibrium with the sun.

Incoming Solar radiation:

$$1368 (R^2 \pi)/(4\pi R^2) \approx 345 \text{ W/m}^2.$$

30% is reflected, the remaining 70% are absorbed and re-emitted as thermal radiation.

Energy Transport

The energy input is larger close to the equator than at the poles, and only through poleward transport of energy by ocean currents, air circulation and latent heat flux, balance is achieved:

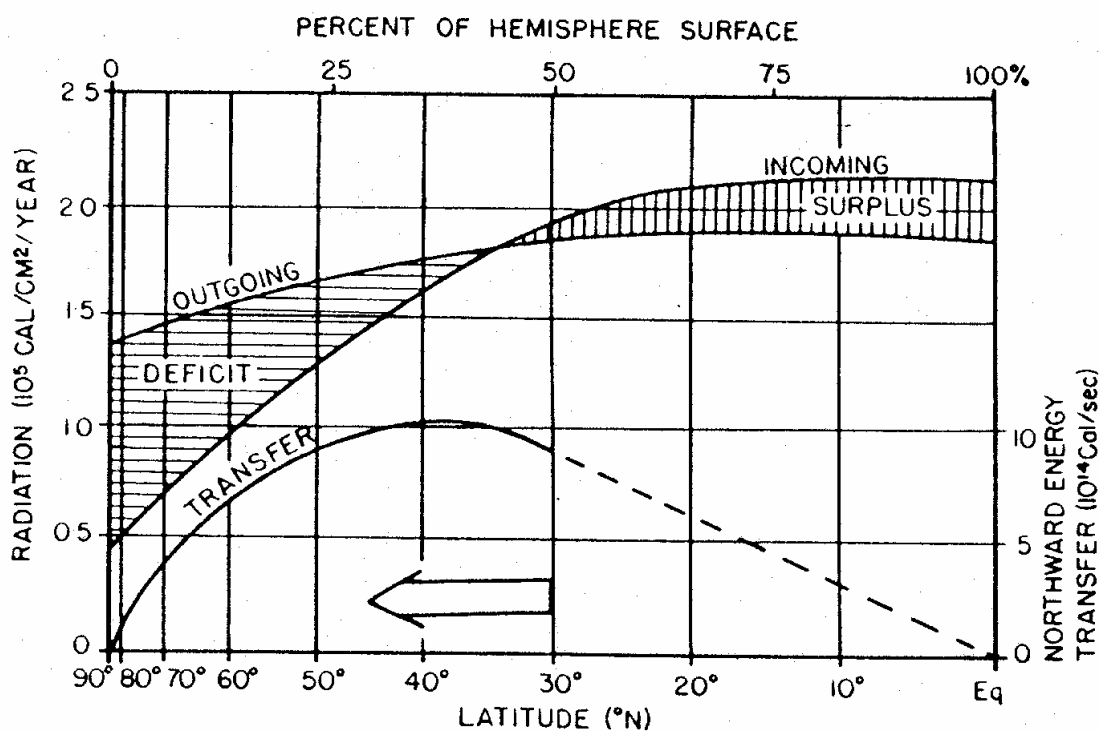

A significant amount of energy is also transported from the surface vertically to the lower troposphere in the form of sensible and latent heat.

The Solar Spectrum

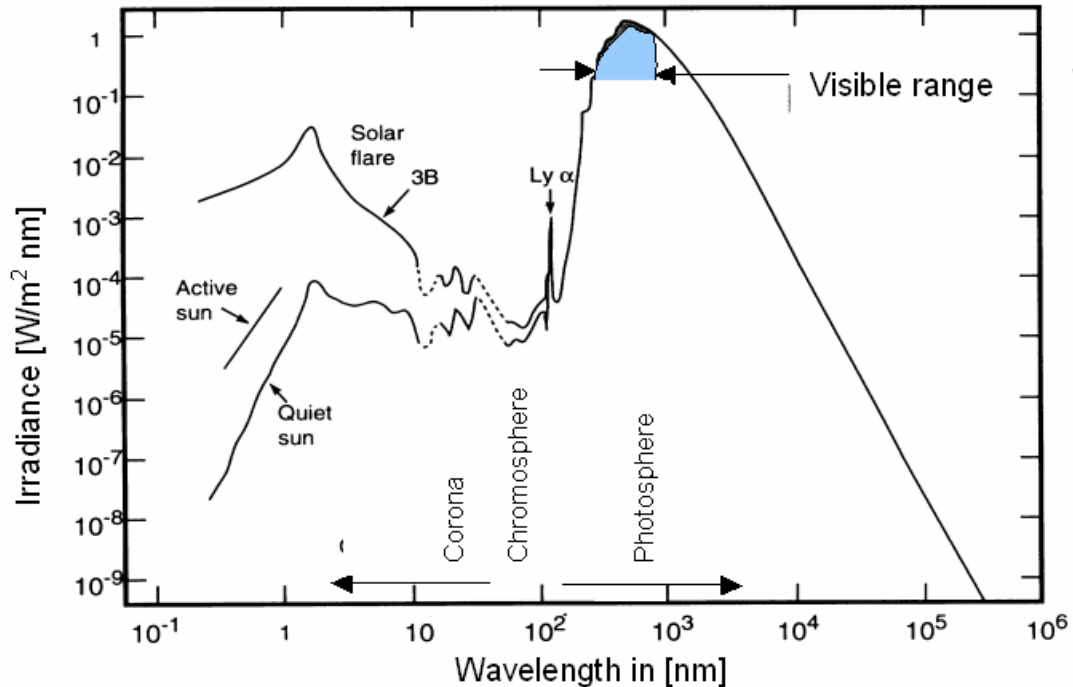

- black body of 5780K in first approximation
- large deviations in the X-ray, far UV and microwave region, where solar emission is many orders of magnitude larger than expected from a black body
- in these spectral regions, the emission is also highly variable and linked to sunspots, flares and the 11 year cycle
- total solar output is constant within a few percent

Penetration depth of solar radiation

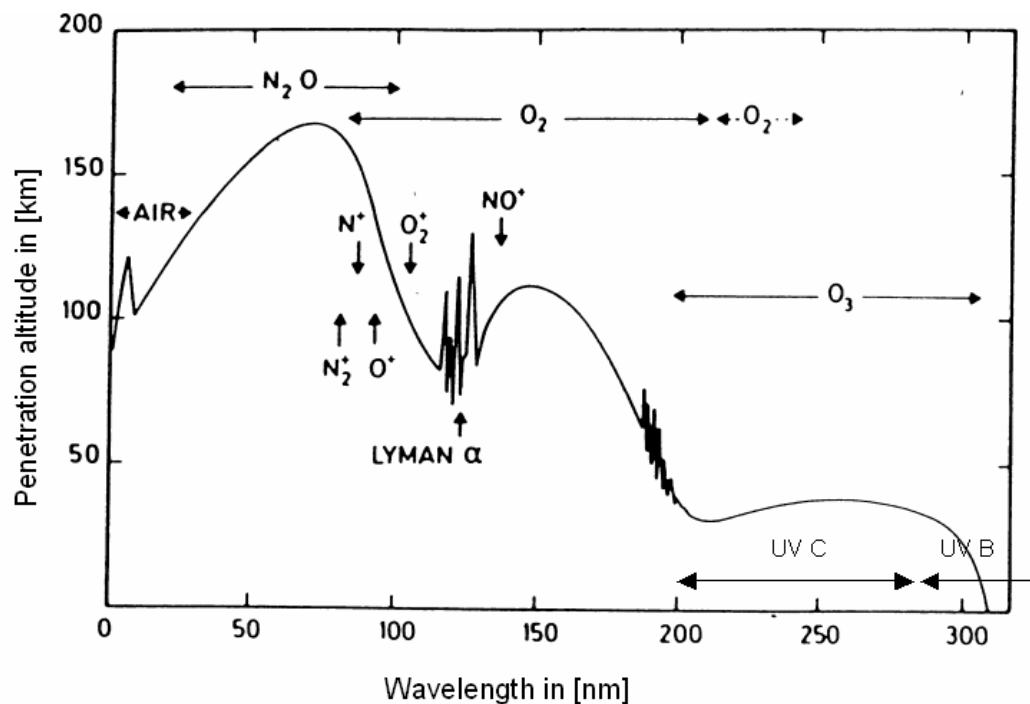

- above 90 km, ionization of air molecules => ionosphere, thermosphere, very high temperatures at low density
- 100..200 nm: photodissociation of O₂, formation of reactive O
- 200..310 nm: photodissociation of O₃ in the ozone layer, stratosphere
- > 310 nm: depends strongly on cloud cover

The energy balance of the upper atmosphere is to a large degree determined by the high energy part of the solar spectrum

Earth Radiation Budget from Space

Several satellites have been deployed to measure the Earth's radiation budget:

- NASA's Earth Radiation Budget Experiment (ERBE) with instruments on Nimbus 6, Nimbus 7, and NOAA-9 and NOAA-10 from 1987 on
- Earth Radiation Budget Satellite (ERBS), launched from Space shuttle in 1984
- Scanner for Radiation Budget ScaRaB on Meteor 1994
- CERES (Clouds and the Earth's Radiant Energy System) on TRMM (2000)
- Geostationary Earth Radiation Budget instrument GERB on MeteoSat-2 2002

Basic idea: Direct measurements of shortwave and longwave outgoing and incoming radiation

Problems:

- very high absolute accuracy needed
- spatial and temporal sampling must be sufficient to exclude biases in the averages

Example of results (solar constant):

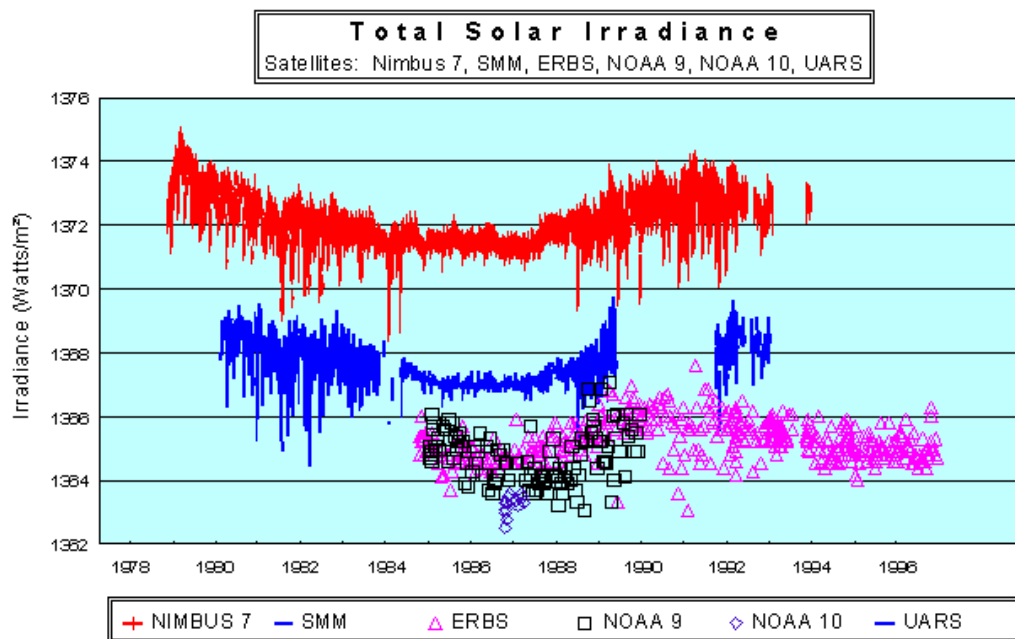

Quantities Relevant for Climate

Input parameters:

- incoming radiation (solar activity, earth's orbit)
- concentrations of IR absorbing gases
- concentrations of aerosols (volcanic eruptions)
- surface albedo (ice and snow coverage)
- cloud cover
- ocean currents (salinity, sea ice)

Affected parameters

- surface temperature
- sea levels
- cloud cover
- precipitation
- frequency of storms / droughts
- ocean currents

IR Absorption by Molecules

Depending on wavelength (= energy), different physical processes are responsible for absorption:

UV	dissociation
VIS	electronic transitions
IR	vibrational transitions
MW	rotational transitions

In practice, combinations of the different processes occur leading to spectra with many lines (one vibration with several rotational transitions)

To absorb in the IR, a molecule must

- have more than one atom
- have the right oscillation frequency
- have a separation of charges (dipole moment) to couple to the electromagnetic waves

Molecules that do not absorb in the IR are

- Ar (one atom)
- N₂, O₂ (no dipole moment)
- CO (symmetric stretch)

Molecules that do absorb in the IR are

- CO₂, H₂O, CH₄, N₂O, CFCs

How efficient the IR absorption by a molecule is, depends on

- concentration of the substance
- atmospheric lifetime of the substance
- absorption cross-section
- position of absorption bands relative to those of other absorbers

Non-linearity of absorption:

Absorption follows **Lambert Beer's law**, and only for very small absorptions it depends linearly on the amount of the absorber.

Therefore, absorbers are most effective in spectral regions, where no other absorbers are present (**Atmospheric Windows**) while in contrast adding more of an already strong absorber changes little in the radiative balance!

Past Climates

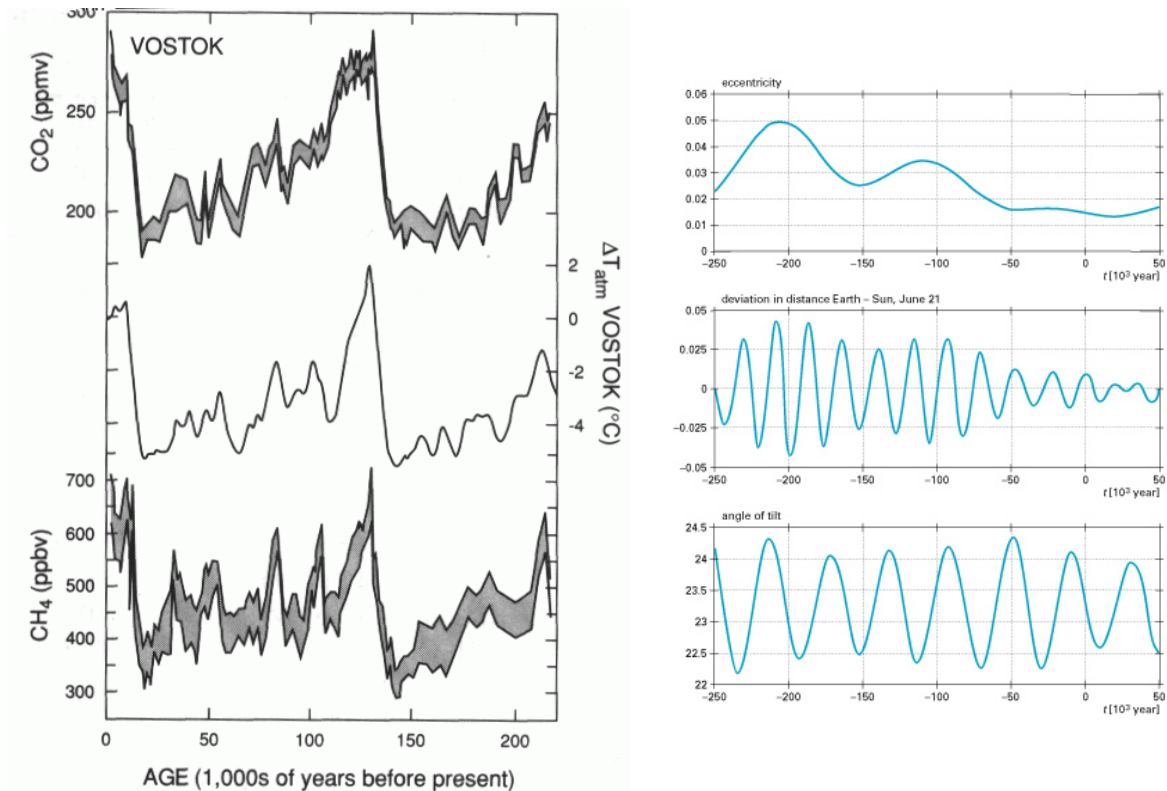

From ice cores, information can be deduced on the abundance of CO_2 and CH_4 as well as temperature in prehistoric times. They demonstrate

- high temperatures at high CO_2 and CH_4 , low temperatures at low CO_2 and CH_4
- large variations in the past
- correlation with earth orbital parameters (**Milankovich Forcing**)?

But: No proof of cause / effect !

Climate Relevance of CO₂

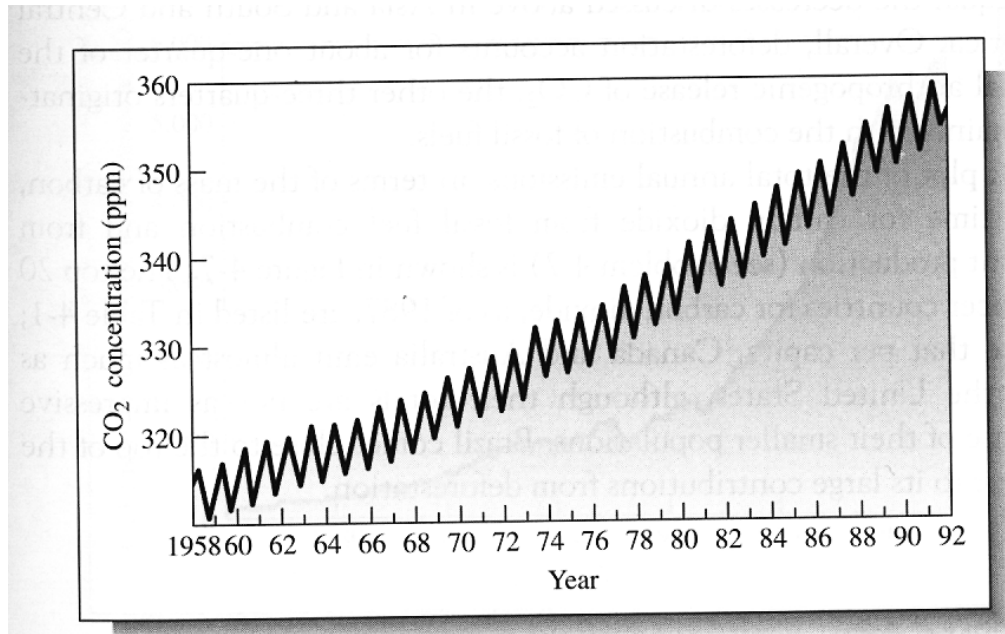

FIGURE 4-6

Yearly variation in atmospheric CO₂ concentrations. The sawtooth variations are due to seasonal effects (see text). (Source: Redrawn from B. Hileman. 1992. *Chemical & Engineering News* (April 27): 7–19.)

- CO₂ is the most important greenhouse gas
- concentrations increased from 280 ppm (pre-industrial) to 356 ppm
- seasonality as a result of photosynthesis, mainly in the northern hemispheric spring and summer and biological decay mainly in fall and winter
- atmospheric lifetime is approx. 100 years

Anthropogenic Sources:

- fossil fuel combustion and cement production (75%)
- biomass burning and deforestation (25%)

Sinks:

- oceans (solution, calcium carbonate formation and deposition)
- forests in the northern hemisphere (growing)

Feedbacks:

- photosynthesis is increased when more CO₂ is available (and often at higher temperature) → negative feedback
- solubility of CO₂ in water is reduced when temperature increases → positive feedback

Climate Relevance of H₂O

- second most important greenhouse gas
- often not explicitly named
- per molecule, H₂O is less effective than CO₂ but much more abundant
- concentrations vary strongly in space and time
- relatively small anthropogenic influence

Feedbacks:

- partial pressure of H₂O increases exponentially with temperature → positive feedback
- cloud formation depends on H₂O concentration
 - high cirrus clouds warm → positive feedback
 - low clouds cool → negative feedback
 - highly uncertain!

Climate Relevance of CH₄

- CH₄ concentrations doubled to 1.7 ppm today
- currently, concentrations are stable for unknown reasons
- highly uncertain emissions
- atmospheric lifetime is about 15 years

Sources:

- wetlands
- fossil fuel use (CH₄ losses in gas transport can offset advantage of using gas instead of coal!)
- landfills
- ruminants
- rice paddies
- forest clearing

Sinks:

- reaction with OH
- transport to stratosphere

Feedbacks:

- change in CH₄ could induce change in OH concentration → negative feedback (possible reason for observed reduction in trend)
- increase in stratospheric H₂O:
$$\text{O}^* + \text{CH}_4 \rightarrow \text{OH} + \text{CH}_3$$
$$\text{OH} + \text{CH}_4 \rightarrow \text{H}_2\text{O} + \text{CH}_3$$
→ positive feedback
- methane from permafrost regions might be released at higher temperatures → positive feedback
- methane (in methane hydrates CH₄:6H₂O) from the ocean floors might be released at higher temperatures → positive feedback

→ **Runaway Greenhouse Effect** possible but rather speculative

Climate Relevance of N₂O

- concentration roughly 0.31 ppm
- growing 9% / year

Sources:

- ocean
- tropical soils
- nitrification / denitrification in soils has N₂O as by-product
- use of fertilizer
- burning of N-containing fuels (coal, biomass)
- older catalytic converters

Sinks:

- stratosphere, photolysis

Feedbacks:

- in the stratosphere, N₂O is a source of NO_x which can lead to ozone destruction → negative feedback

Climate Relevance of CFCs

- completely anthropogenic sources
- long lifetime
- very strong absorption
- very effective greenhouse gases

Feedbacks:

- ozone destruction in the stratosphere → negative feedback, cancels warming effect (but not at the same altitude!)

CFC replacements (HCFC and HFC) are often also effective greenhouse gases, albeit with a shorter lifetime.

Climate relevance of O₃

- important natural greenhouse gas in the stratosphere
- in the troposphere less important due to overlap with CO₂ absorption
- in the troposphere variable in space due to short lifetime

Climate Relevance of Aerosols

- aerosols have a multitude of conflicting effects on climate
- sulphate aerosols mostly reflect solar light → net cooling
- soot mostly absorbs light → net warming
- aerosols provide condensation nuclei that affect
 - cloud formation
 - cloud droplet size → reflectivity (larger for smaller droplets)
- aerosols tend to cool in mid-latitudes and heat at low latitudes, leading to changes in temperature gradients
- many feedbacks exist for aerosol deposition, cloud formation and increased aerosol production in drier climates

Sources:

- sea-salt
- soils
- anthropogenic SO₂ emissions
- DMS emissions

Quantification of Climate Relevance

The climate relevance of a species is often given as the **Radiative Forcing** = net change in radiative energy flux at the tropopause to changes in the concentration of a given trace gas

To simplify calculations, everything is given relative to the effect of CO₂:

Effective Carbon Dioxide Concentration = concentration of CO₂ that leads to same change in surface temperature

Often, **Indirect Effects** are also important and much more difficult to quantify:

Direct radiative forcing relative to CO ₂ per unit molecule change		
	<i>Clear sky</i>	<i>Clouds</i>
CO ₂	1	1
CH ₄	25	23
N ₂ O	213	210
CFC-11	13000	11700
CFC-12	16800	14900
CFC-113	18500	16000
HCFC-22	9700	8300
Indirect radiative forcing relative to CO ₂ per unit molecule change		
	<i>Clear sky</i>	<i>Clouds</i>
CO ₂	1	1
CH ₄	42	41
N ₂ O	250	240
CFC-11	8000	6900
CFC-12	16600	15000

Global Warming Potentials

Table 15.5

Species	Formula	Lifetime (yrs)	Global Warming Potential		
			T=20 years	100 years	500 years
Carbon dioxide	CO ₂		1	1	1
Methane	CH ₄	12-18 ^a	48-90	20-43	8-15
Nitrous oxide	N ₂ O	121	290	330	180
CFC-11	CFCl ₃	50	5000	4000	1400
CFC-12	CF ₂ Cl ₂	102	7900	8500	4200
CFC-113	CF ₂ ClCFCl ₂	85	5000	5000	2300
HCFC-22	CF ₂ HCl	13.3	4300	1700	520
HCFC-142b	CH ₃ CF ₂ Cl	19.5	4200	2000	630
Carbon tetrachloride	CCl ₄	42	2000	1400	500
Methyl chloroform	CH ₃ CCl ₃	5.4	360	110	35
HFC-134a	CH ₂ FCF ₃	14	3300	1300	420
Halon-1301	CF ₃ Br	65	6200	5600	2200

^aIncludes the dependence of the methane abundance on the response time (indirect effect associated with changes in OH density).

For each substance, a **Global Warming Potential** is computed, that gives the time integrated change of radiative forcing due to the instantaneous release of 1 kg of a trace gas relative to the effect of the release of 1 kg CO₂

The global warming potential depends on the time interval treated and also on many other assumptions!

Is There a Man-Made Greenhouse Effect?

Indicators of the human influence on the atmosphere during the Industrial Era

(a) Global atmospheric concentrations of three well mixed greenhouse gases

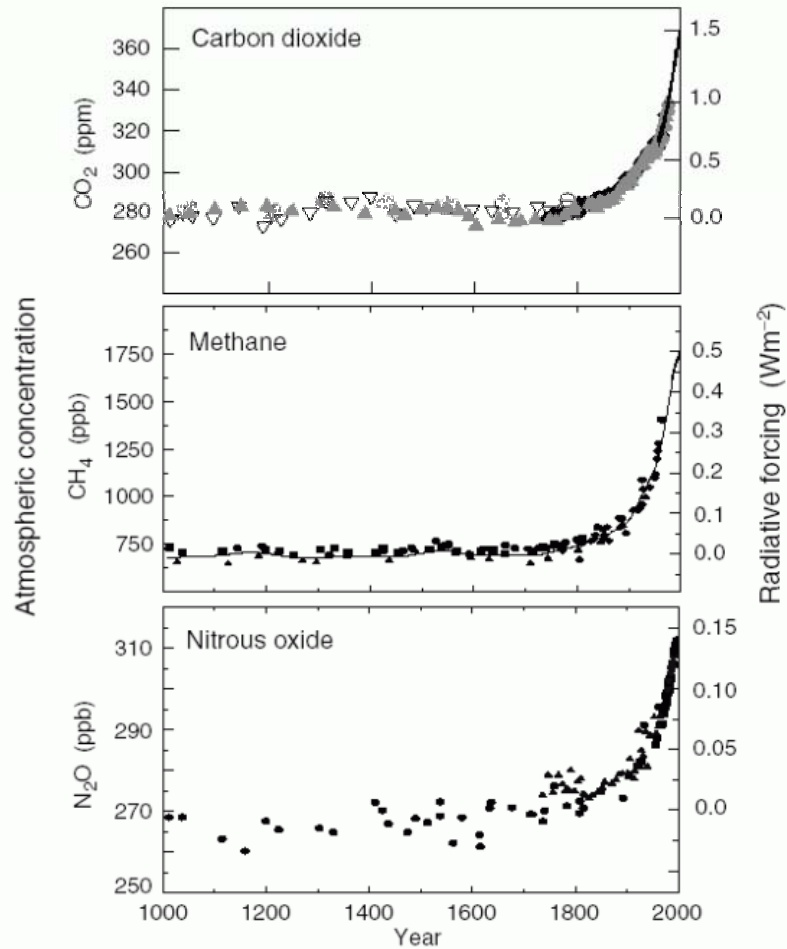

(b) Sulphate aerosols deposited in Greenland ice

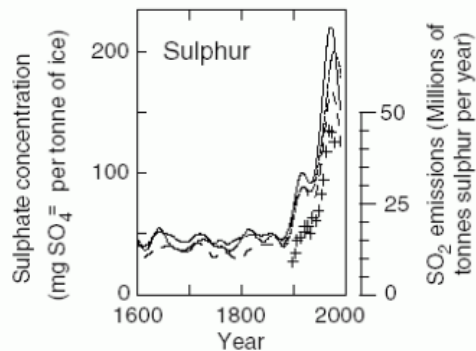

Is Temperature Changing on Earth?

Variations of the Earth's surface temperature for:

(a) the past 140 years

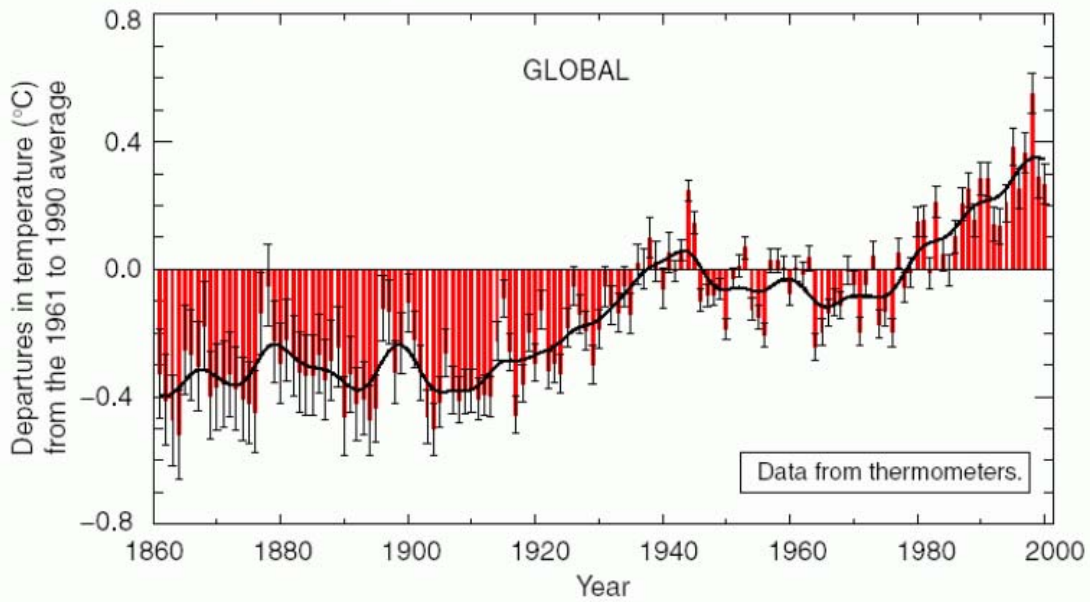

(b) the past 1,000 years

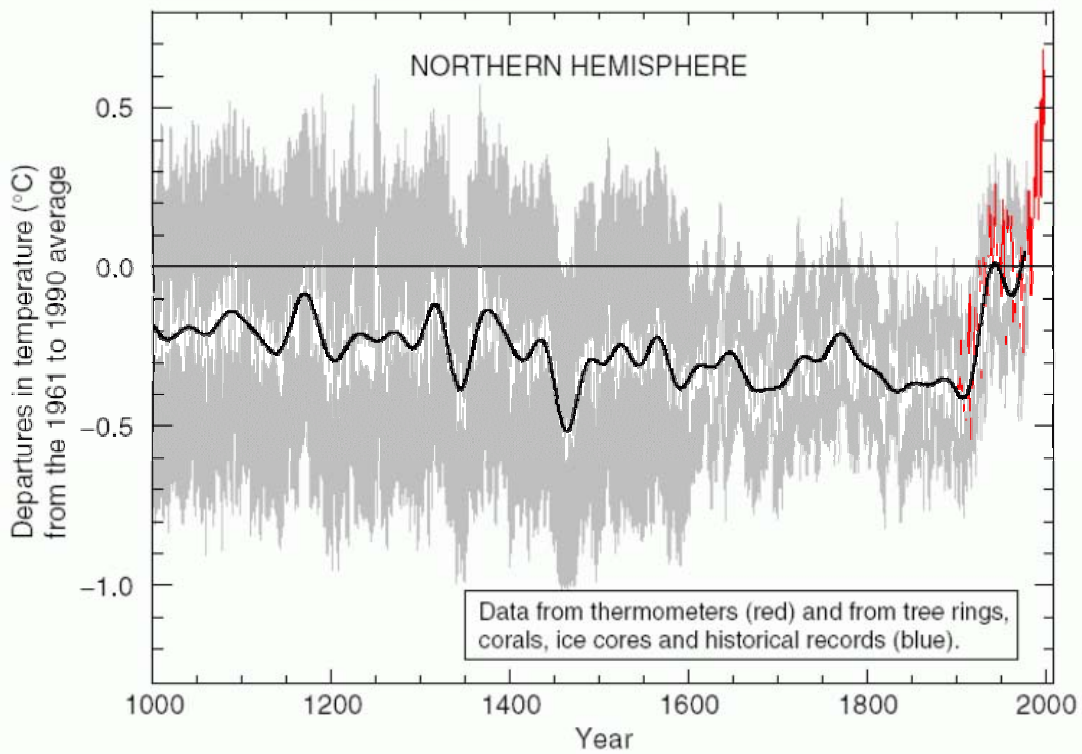

What are the Main Contributions to GW?

The global mean radiative forcing of the climate system for the year 2000, relative to 1750

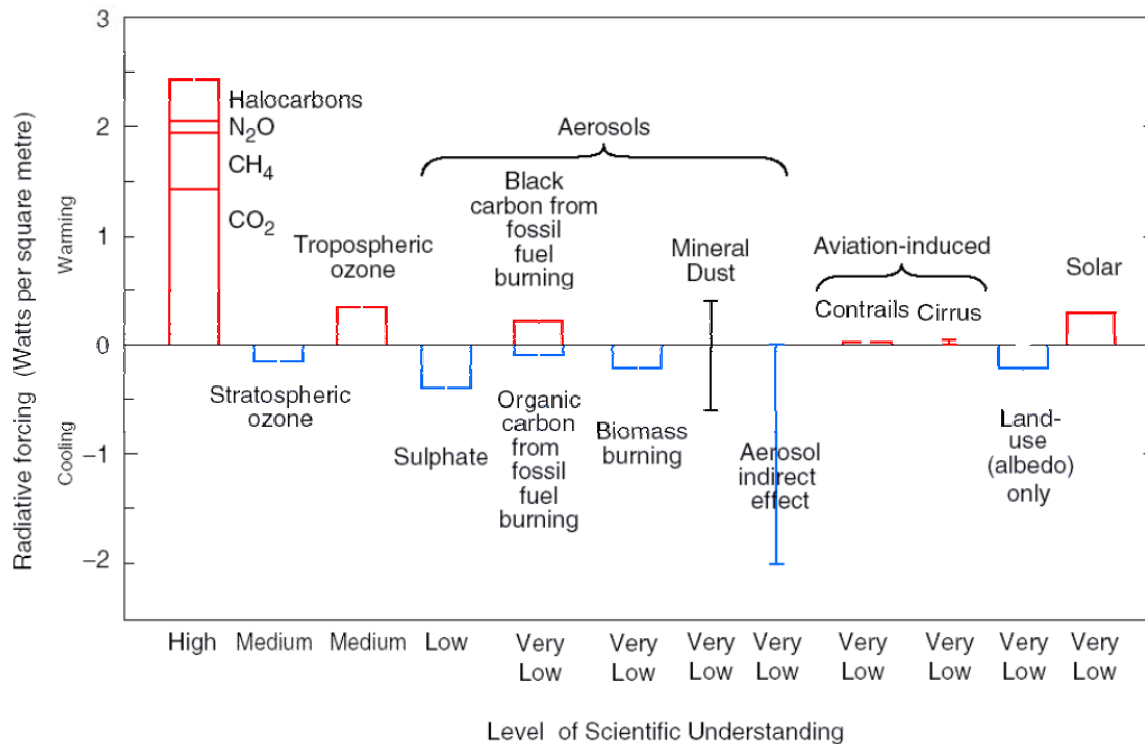

- many contributions are still not well quantified
- in particular aerosol effects are very uncertain
- the impact of CO₂ and CH₄ is well understood

How well do Models?

Simulated annual global mean surface temperatures

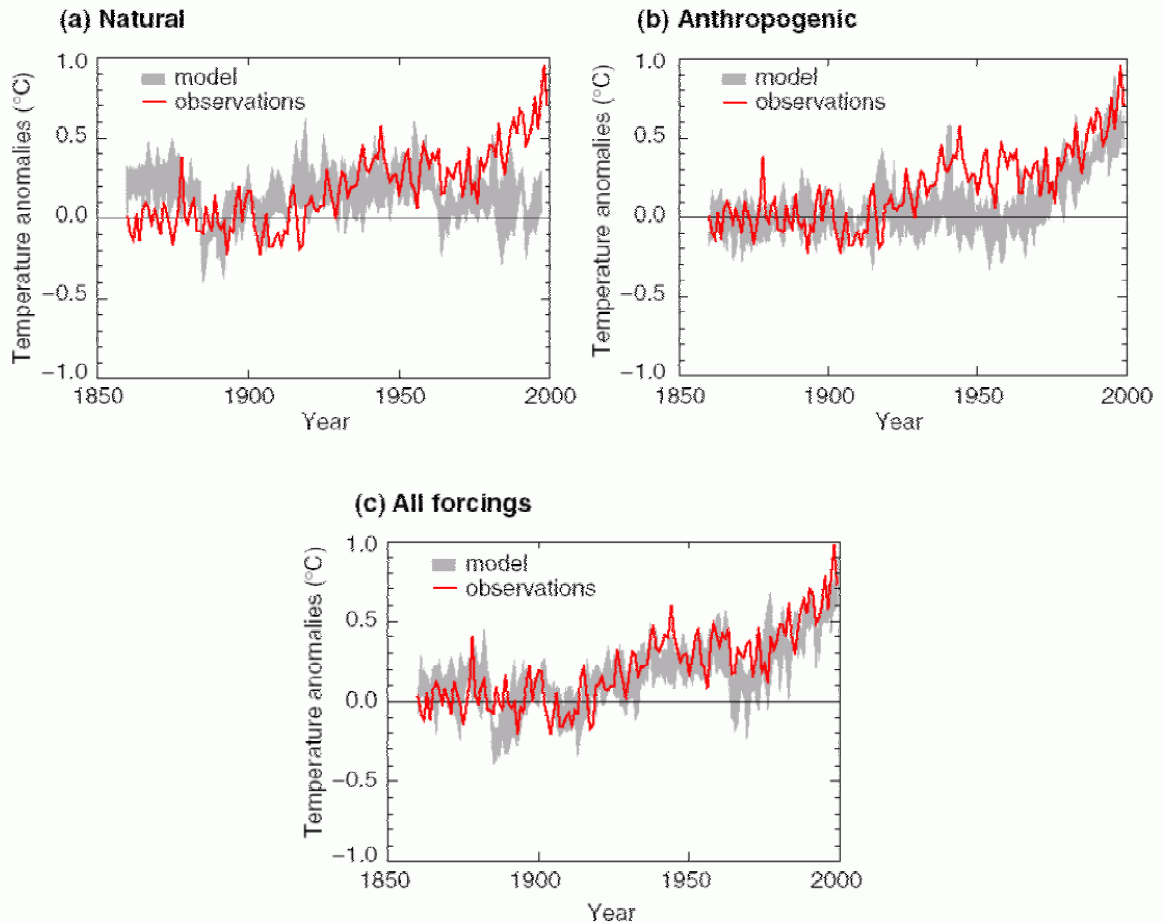

- models can qualitatively reproduce past temperature changes
- climate models still are rather simplistic
- chemistry is not well represented in climate models, which might have a big impact on the predictions
- input for models is still rather uncertain

What do Models Predict?

The global climate of the 21st century

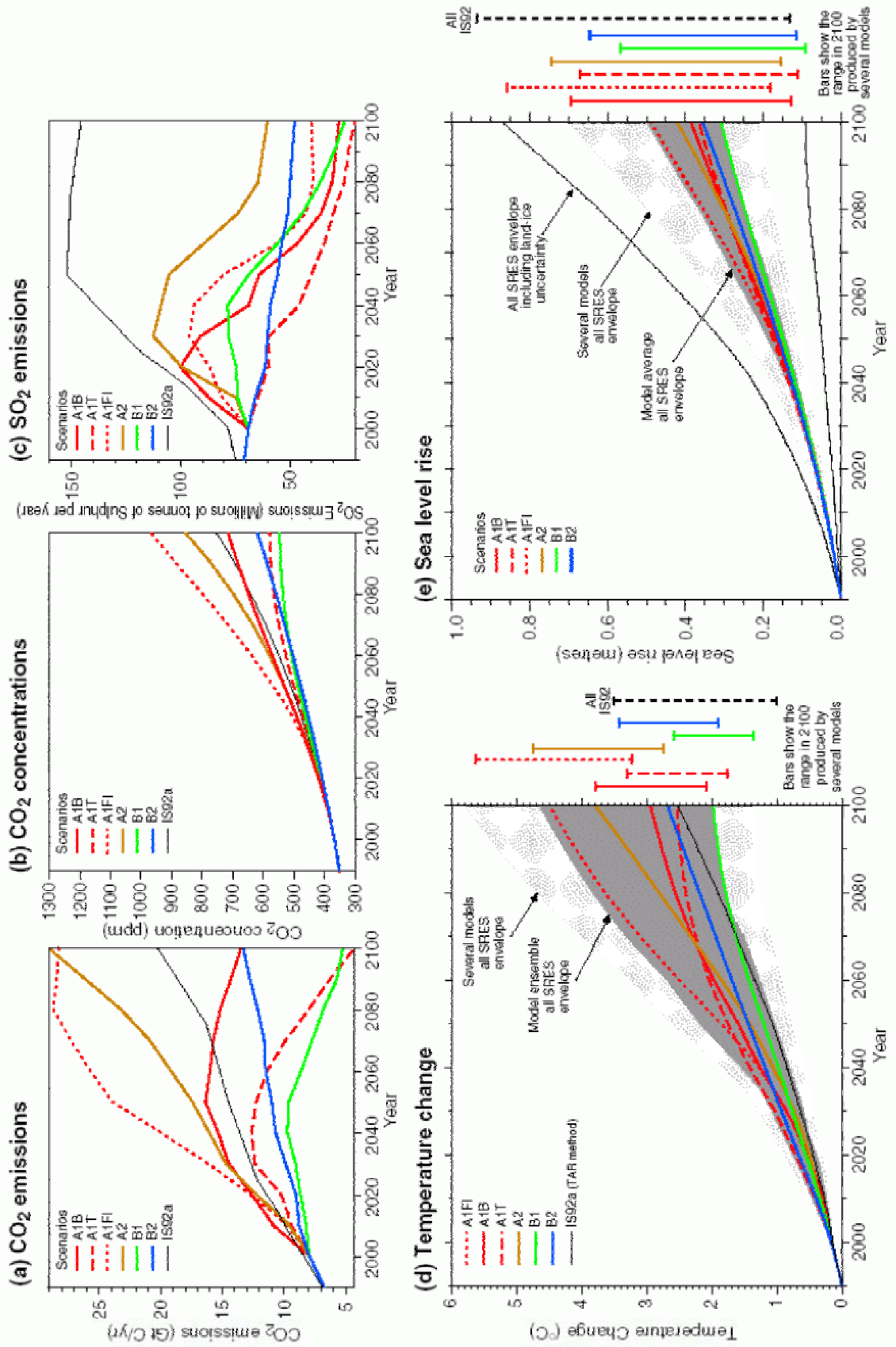

Summary Greenhouse Effect

- the natural greenhouse effect is crucial for the current moderate temperatures at the Earth surface
- the concentration of many greenhouse gases in the atmosphere increases as a result of human activities
- eventually, larger concentrations of CO₂ and others will increase temperatures on Earth
- temperature on Earth has already increased significantly in the last 100 years
- it is probable but not sure that the increase in greenhouse gases is the (only) reason for the observed increase in temperature
- many feedback processes make quantitative predictions difficult
- in particular aerosols play different roles in the climate system and can lead to both warming and cooling depending on conditions

Work, Heat and Energy

A **system** is a part of the world in which we have a special interest, such as a reaction vessel or an air parcel.

The energy of a system can be changed by doing (mechanical) **work** on it; in the atmosphere this is done by changing the volume.

The energy of a system can also be changed by transferring **heat** as a result of a temperature difference between system and surroundings.

A change in state of the system that is performed without heat being transferred is called **adiabatic**.

A process that releases energy is **exothermic**, a process that absorbs energy is called **endothermic**.

By convention, energy supplied to a system is written positive, energy that has left the system is negative.

Energy and Enthalpy

The **Internal Energy U** is the total energy of a system.

A change in internal energy of a system is the sum of the changes of energy through work dW and heat dQ :

$$dU = dQ + dW = TdS - pdV$$

For a system with constant volume, no mechanical work is performed and the change in internal energy equals the transferred heat:

$$dU = dQ|_V$$

The **Enthalpy** of a system is defined as

$$H = U + pV.$$

At constant pressure, a change in enthalpy equals the transferred heat:

$$dH = dQ|_p$$

Internal Energy and Enthalpy are **State Functions** that depend only on the state of the system and not on the way how it was achieved. This is not true for Q and W !

Entropy

The internal energy U is a state function that lets us assess if a process is permissible, the **Entropy** S is a state function that tells us, which processes proceed spontaneously.

The **statistical definition of Entropy** S is

$$S = k \ln W$$

where k is Boltzmann's constant and W the number of possible states of the system giving the same energy.

The **thermodynamic definition of an Entropy** change dS is

$$dS = \frac{dQ}{T}$$

where dQ is the transfer of heat taking place at temperature T .

Both definitions are identical.

In general, only processes can occur that lead to an overall increase in entropy in system and surroundings.

Heat Capacities

The **heat capacity** C of a system is the amount of heat Q needed to change the temperature T of a system: $dQ = CdT$.

The heat capacity of a system depends on the conditions:

The **heat capacity at constant volume** C_V is related to the change in internal energy U :

$$C_V = \left(\frac{\partial U}{\partial T} \right)_V$$

The **heat capacity at constant pressure** C_p is related to the change in enthalpy H :

$$C_p = \left(\frac{\partial H}{\partial T} \right)_p$$

At constant pressure, work is performed by the system during heating, and therefore

$$C_p > C_V$$

For an ideal gas, $C_p - C_V = nR$

Laws of Thermodynamics

0th law: If A is in thermal equilibrium with B, and B is in thermal equilibrium with C, then C is also in thermal equilibrium with A.

1st law: The internal energy U of a system is constant unless it is changed by doing work (W) or by heating (Q):

$$\Delta U = Q + W$$

2nd law: The entropy S of an isolated system increases in the course of a spontaneous change:

$$\Delta S_{tot} > 0$$

3rd law: The entropy change of a transformation approaches zero as the temperature approaches zero:

$$\Delta S \rightarrow 0 \text{ as } T \rightarrow 0$$

State Functions: Examples

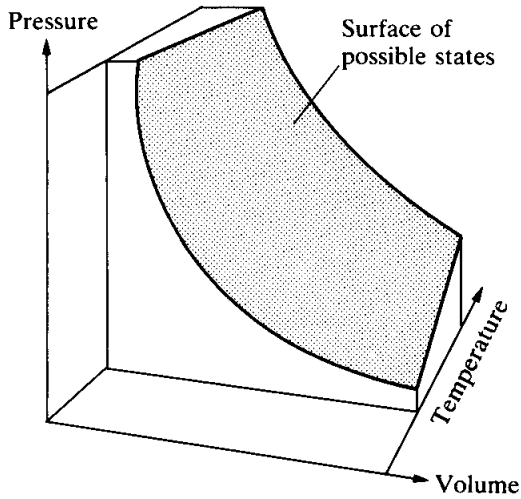

Fig. 1.4 A region of the p, V, T surface of a fixed amount of perfect gas. The points forming the surface represent the only states of the gas that can exist.

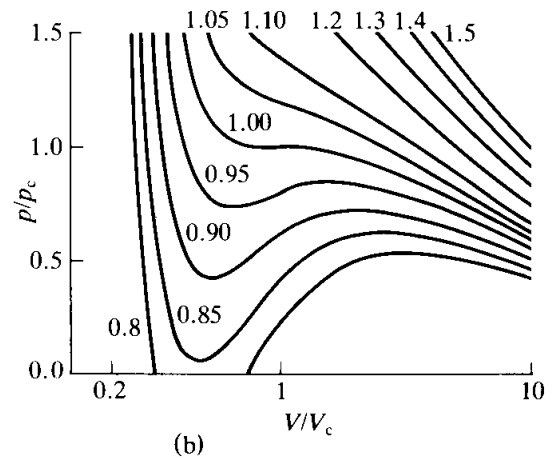
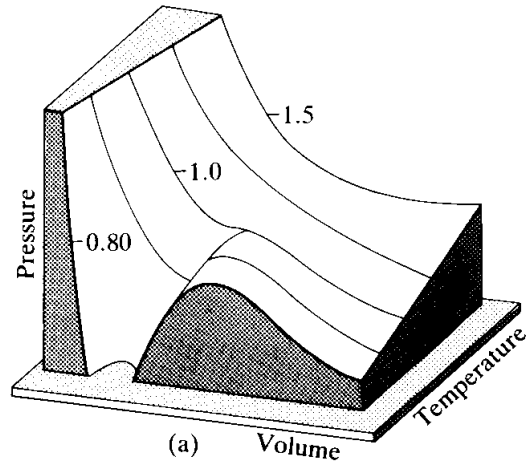

Fig. 1.10 The van der Waals isotherms at several values of T/T_c . (a) The shape of the surface (compare it with the perfect gas surface in Fig. 1.4). (b) A selection of individual isotherms. The van der Waals 'loops' are normally replaced by horizontal straight lines. The critical isotherm is the one at $T/T_c = 1$.

Phase Changes

An ideal gas is a gas independent of pressure and temperature. In real gases, however, forces between the molecules and also the finite volume of the individual molecules result in phase changes at certain temperatures and pressures.

If a liquid is heated its temperature increases according to its heat capacity. However, if the boiling temperature is reached, further energy input does not result in increased temperature but only in more evaporation until the whole liquid has changed its phase.

The energy needed to melt ice or evaporate a liquid is called **latent heat**. It can be recovered during condensation or sublimation.

Phase Diagram of Water

A **phase diagram** shows the regions of pressure and temperature at which the various phases of a substance are thermodynamically stable. The **phase boundaries** are the values of p and T where two phases coexist in equilibrium.

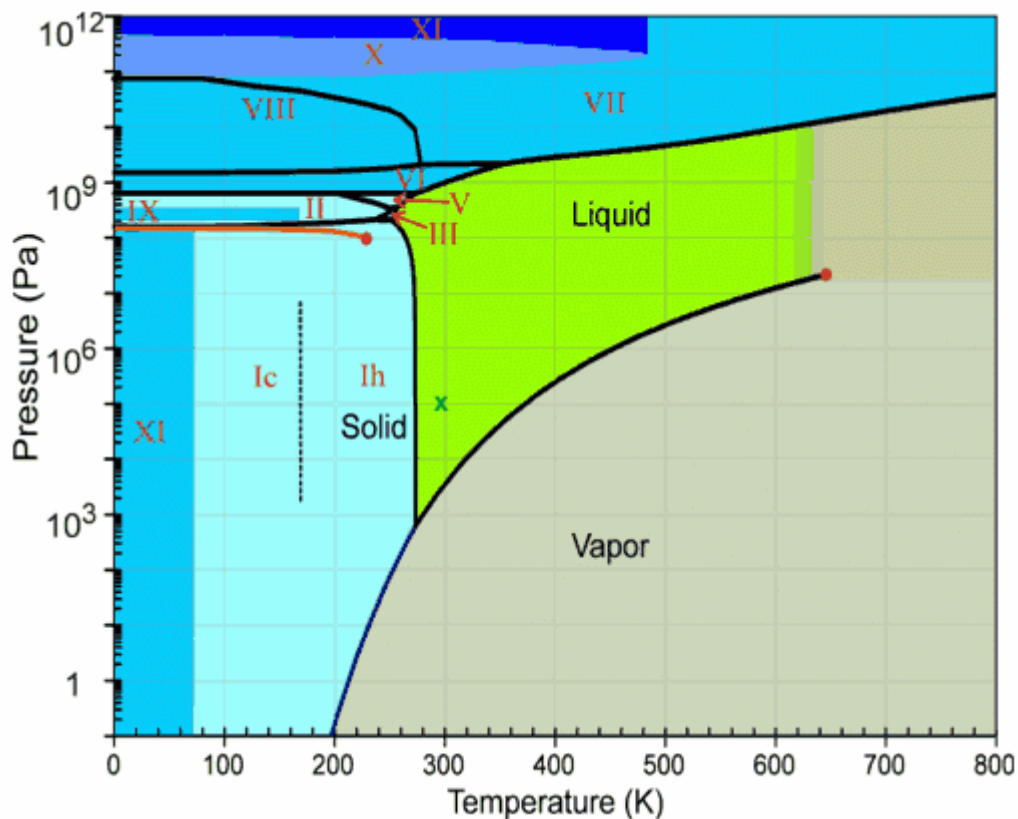

Note the slight backward tilt of the solid - liquid phase boundary which is unique to water (and useful for ice skating).

Water in the Atmosphere

The amount of water in a given air volume is crucial for its ability to transfer energy.

Common moisture parameters are:

mass mixing ratio: $w = \frac{m_v}{m_d}$ where m_v is the mass

of water vapour and m_d the mass of dry air

saturation vapour pressure: the vapour pressure that is reached in equilibrium above a plane surface of pure water e_s or over ice e_{si} . Note that e_s and e_{si} depend only on temperature and that $e_s > e_{si}$ at all temperatures.

relative humidity: $RH = 100 \frac{w}{w_s}$

dew point: Temperature at which water vapour in a given air volume would start to condensate

frost point: Temperature at which water vapour in a given volume would start to freeze

Clausius-Clapeyron equation

The variation of equilibrium vapour pressure e_s with temperature is given by the Clausius-Clapeyron equation:

$$\frac{de_s}{dT} = \frac{L_v}{T(\alpha_g - \alpha_l)}$$

where L_v is the latent heat of evaporation, α_l the specific volume of the liquid and α_g the specific volume of the gas phase.

If the small specific volume of the liquid phase is ignored, and the ideal gas law applied, the following approximation follows:

$$\frac{de_s}{dT} = \frac{e_s L_v M_w}{RT^2}$$

where M_w is the molar mass of water. If the temperature dependence of L_v is ignored, the equation can be integrated to

$$e_s = e_{s0} \exp\left(\frac{L_v M_w}{RT_0} \frac{T - T_0}{T}\right)$$

where e_0 is the saturation pressure at temperature T_0 .

Water Saturation Pressure

Saturation pressure of water vapor as a function of temperature. The amount of H_2O present is shown by the water in a measuring cylinder if all the vapor in a kilogram of saturated air at sea level were condensed and put in the cylinder.

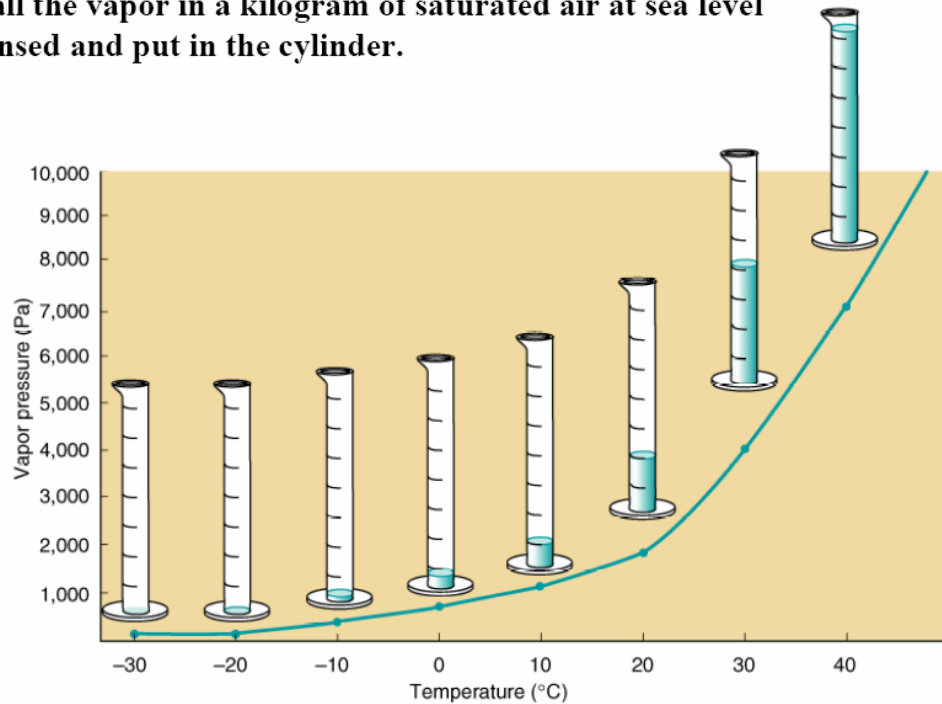

Copyright 1999 John Wiley and Sons, Inc. All rights reserved.

- water saturation pressure is an exponential function of temperature
- small changes in temperature have a large effect on the amount of water that *can* be present as water vapour

Every day's examples:

- dry air in heated rooms
- “fogging” of glasses
- white plumes above chimneys

Water / Ice Saturation Pressure

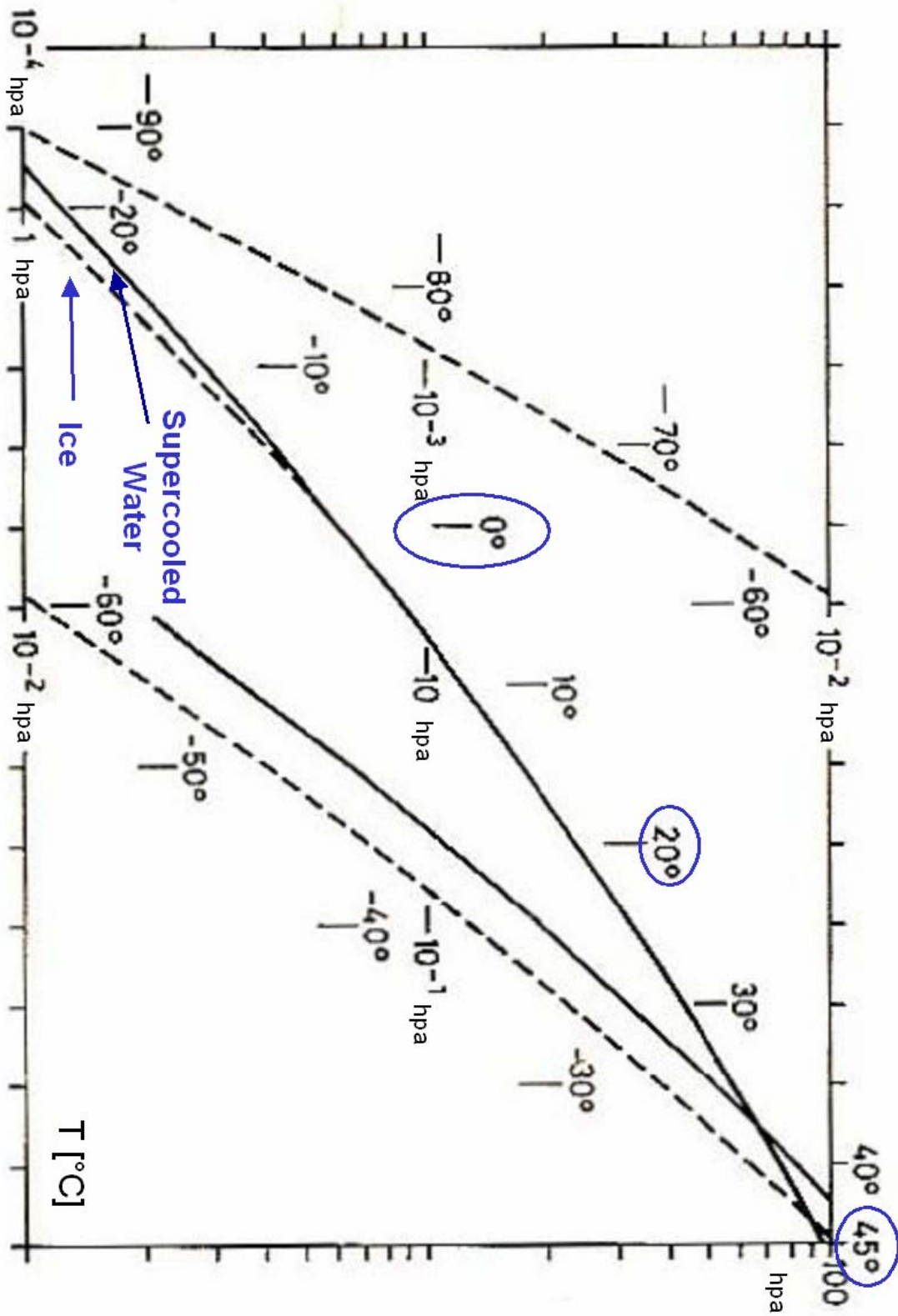

please note the different scales!

Latent Heat

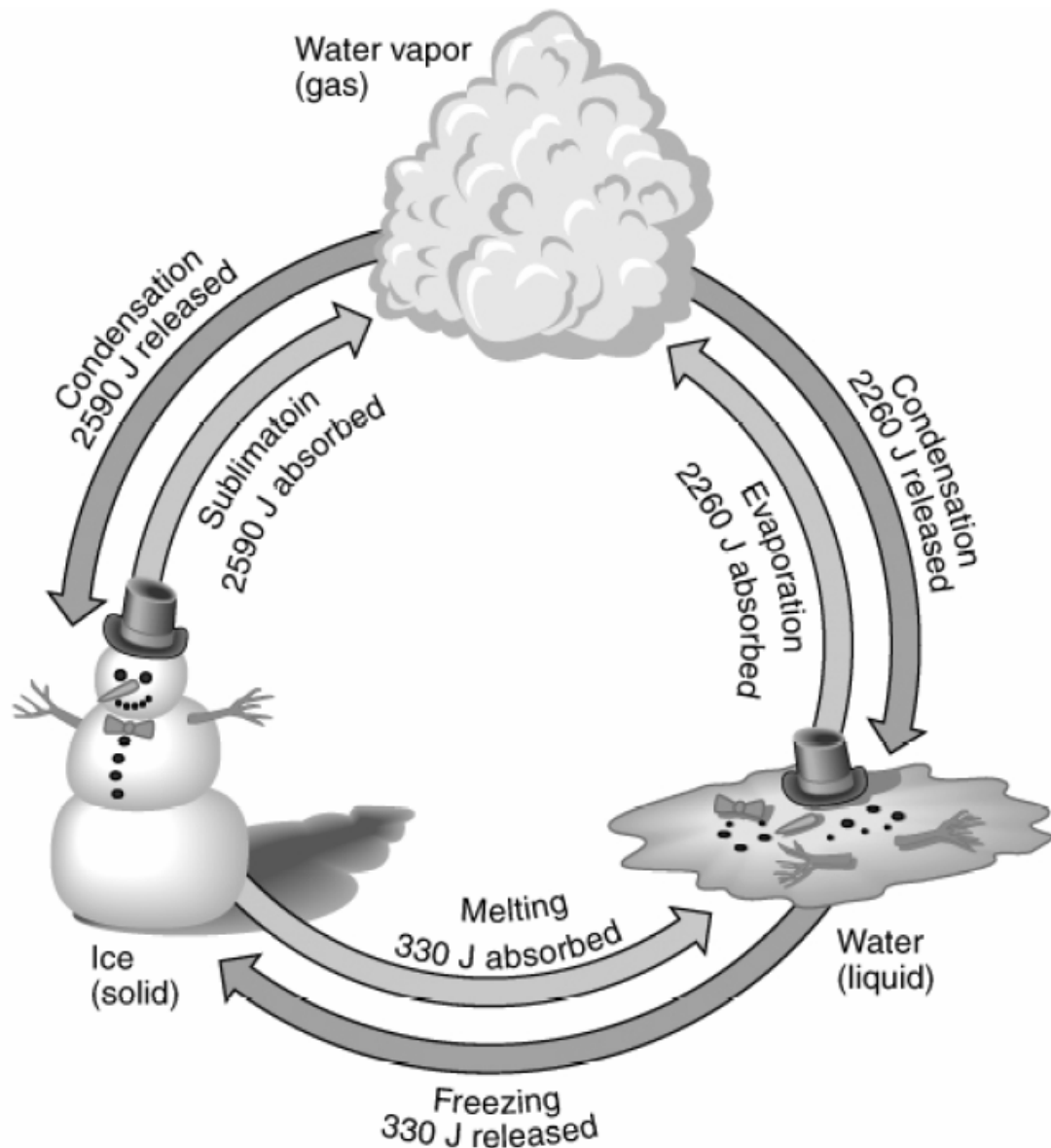

Copyright 1999 John Wiley and Sons, Inc. All rights reserved.

The energy needed to evaporate 1 kg of water is about three times as large as the energy needed to heat it from 0°C to 100°C!

Water Vapour Measurements

Hair Hygrometer: Length of a human hair or other fine thread is expanding in moist air

Semiconductor Hygrometer: Some semiconductors change resistance as a function of humidity

Frost Point Hygrometer: A mirror is cooled and the temperature at which it is fogged by condensation / frost is recorded:

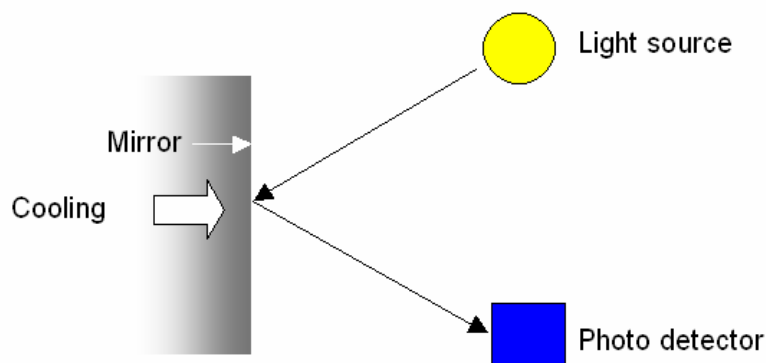

Psychrometer: A wet and dry bulb thermometer measure the temperature difference between a wet and a dry thermometer, which depends on air humidity

Absorption Measurements

Water Cycle

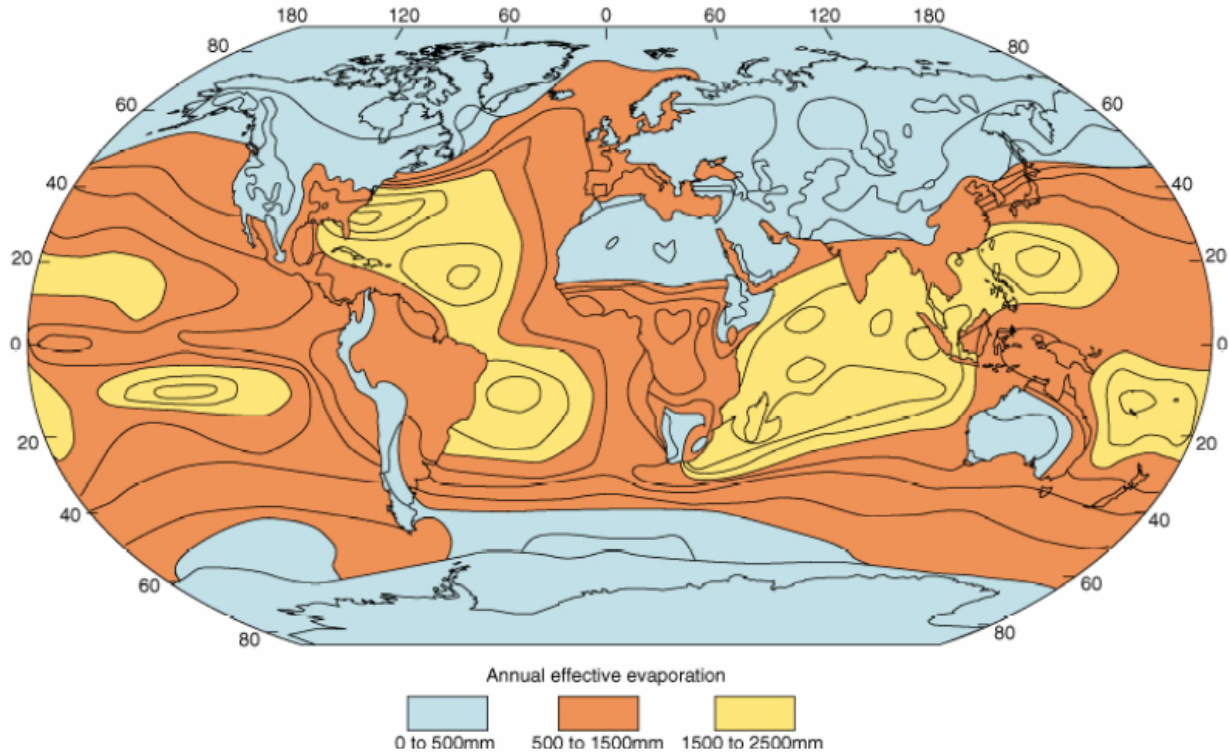

Copyright 1999 John Wiley and Sons, Inc. All rights reserved.

- most water is evaporated over the oceans
- mostly in the tropics (high temperatures)
- low evaporation over deserts and mountains (low humidity)
- water vapour is transported to the continents as clouds where it rains out and eventually is brought back through rivers

Air Parcels

Mixing in the atmosphere can be obtained by two types of processes:

molecular diffusion: small scale ($< 1\text{cm}$) and in the upper atmosphere

turbulent and convective mixing: dominant below 100 km

In turbulent and convective mixing, one imagines “air parcels” to be moved around, which have dimensions of several meters up to 1000 km (horizontally).

Air parcels are by definition

- thermally well insulated (adiabatic processes)
- have always the same pressure as the environment
- have negligible kinetic energy ($U_{\text{int}} \gg E_{\text{kin}}$)

Although these conditions are usually not all fulfilled, air parcels still prove to be a useful concept.

Cooling or Warming at Constant p

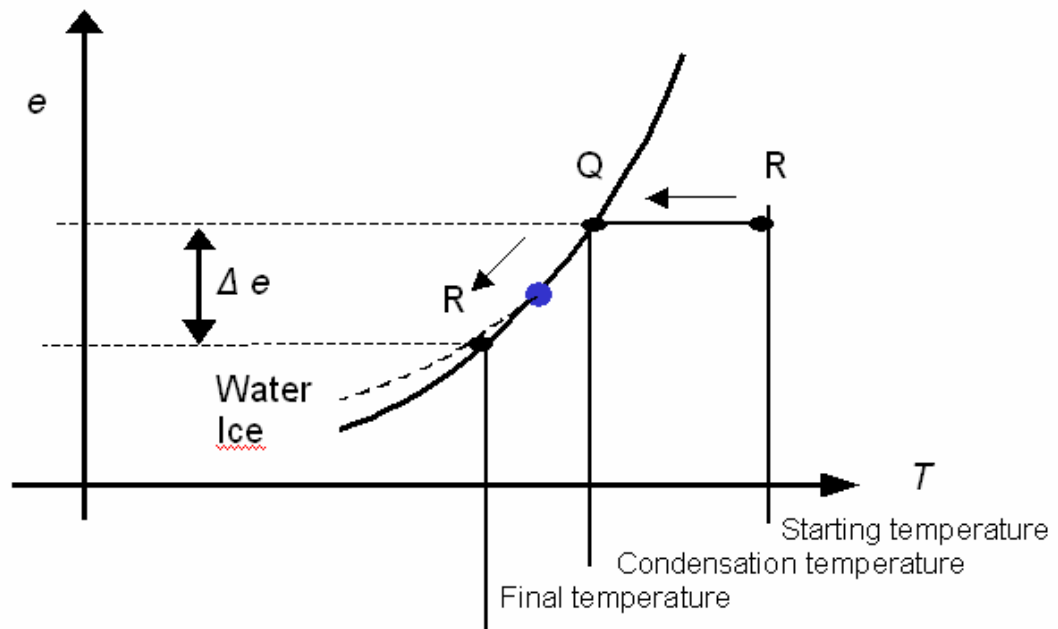

- cooling an air parcel isobarically from R to Q will increase the relative humidity as e_s decreases
- further cooling will lead to condensation (fog formation) and a reduced cooling rate
- this is the explanation for “radiation fog” that forms close to the surface that loses energy through radiation at night under cloud free conditions

Horizontal Mixing



Under certain conditions, the mixing of two air masses which are not saturated can lead to condensation, for example in air craft contrails.

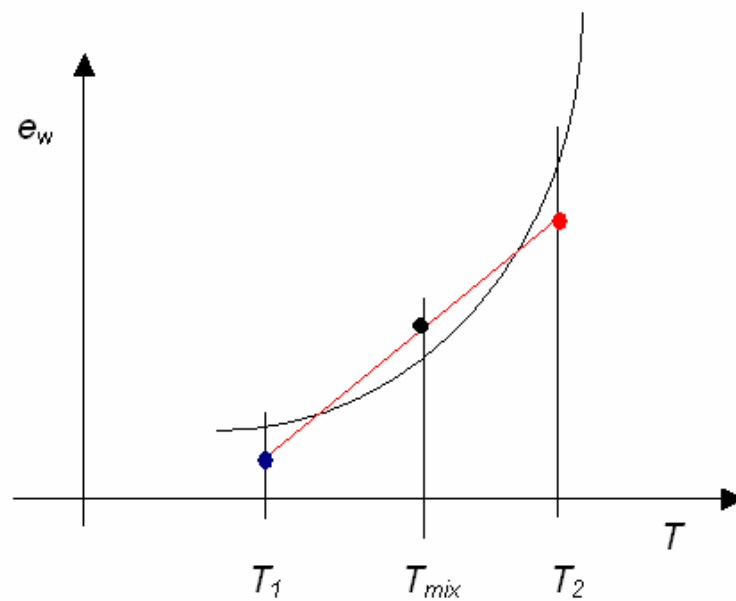

Adiabatic Expansion / Compression

When moving an air parcel vertically in the atmosphere, one can assume that no heat is exchanged with the surroundings (adiabatic). How is the temperature changing in such a process?

First Law:

$$dU = dQ + dW = dQ - pdV$$
$$dU = C_V dT$$

Adiabatic:

$$dQ = 0 \rightarrow C_V dT = -pdV$$

Ideal gas law (1 mole):

$$pV = RT \rightarrow Vdp + pdV = RdT$$

Insert:

$$C_V dT = Vdp - RdT$$

$$(C_V + R)dT = Vdp$$

$$C_p dT = Vdp$$

$$C_p dT = \frac{RT}{p} dp$$

$$\frac{dT}{T} = \frac{R}{C_p} \frac{dp}{p}$$

By integrating we find the **Poisson equation**:

$$\int_{T_0}^T \frac{dT}{T} = \int_{p_0}^p \frac{R}{C_p} \frac{dp}{p}$$

$$\ln\left(\frac{T}{T_0}\right) = \frac{R}{C_p} \ln\left(\frac{p}{p_0}\right)$$

$$\frac{T}{T_0} = \left(\frac{p}{p_0}\right)^{\frac{R}{C_p}}$$

$$T p^{\frac{R}{C_p}} = T_0 p_0^{\frac{R}{C_p}}$$

$$\frac{T^\kappa}{p^{\kappa-1}} = \text{const} \quad \kappa = c_p / c_v$$

From the hydrostatic equation, we know that

$$\frac{dp}{p} = -\frac{Mg}{RT} dz$$

Thus

$$\frac{C_p}{RT} dT = -\frac{Mg}{RT} dz$$

and finally the **adiabatic lapse rate**

$$\boxed{\Gamma = \frac{dT}{dz} = -\frac{Mg}{C_p}}$$

For dry air, the adiabatic lapse rate is approximately

$$\frac{dT}{dz} = -\frac{28.97 \text{ gMol}^{-1} 9.81 \text{ ms}^{-2}}{28.97 \text{ JK}^{-1} \text{ Mol}^{-1}} \approx -1 \text{ K} / 100 \text{ m}$$

Potential Temperature

Starting from the adiabatic lapse rate, a new temperature can be defined that is the temperature an air parcel would have if brought adiabatically to $p_0 = 1013 \text{ mbar}$. The potential temperature Θ can be derived using the Poisson equation:

$$\frac{T^\kappa}{p^{\kappa-1}} = \text{const} = \frac{\Theta^\kappa}{p_0^{\kappa-1}}$$

Potential Temperature: $\Theta = T \left(\frac{p_0}{p} \right)^{\frac{\kappa-1}{\kappa}}$

The potential temperature is a measure of the sum of potential and internal energy and often a conserved quantity. $((\kappa - 1) / \kappa = 0.286 \text{ in air})$

Pseudoadiabatic Lapse Rate

When considering humid air (no condensation), the change in heat capacity must be considered, but the effect is very small (see exercises),

Things change significantly, if moist air is treated, and condensation takes place. Latent heat released during condensation is increasing the temperature and thereby reduces the temperature gradient.

In contrast to the dry case, dQ is not zero but equals the amount of released latent heat L_v :

$$dQ = C_p dT - \frac{RT}{p} dp$$

$$dQ = C_p dT + Mg dz$$

As condensation depends only on the number of moles water vapour, we multiply with $n/V = p/RT$:

$$dQ = \frac{C_p p}{RT} dT + \frac{Mgp}{RT} dz = -L_v dw_s$$

where dw_s is the absolute humidity at saturation pressure.

As dw_s is a function of temperature,

$$\frac{C_p p}{RT} dT + \frac{Mgp}{RT} dz = -L_v \frac{dw_s}{dT} dT$$

and finally the **pseudoadiabatic lapse rate** is

$$\frac{dT}{dz} = - \frac{Mgp}{C_p p + RT L_v \frac{dw_s}{dT}}$$

The water saturation mixing ratio w_s is linked to the water saturation pressure which can be determined using the Clausius-Clapeyron equation.

The pseudoadiabatic lapse rate is always smaller than the adiabatic lapse rate. How much it differs from the adiabatic lapse rate depends on temperature; at high temperatures, the difference increases. At low temperatures (0..5°C) a typical value is 0.5K/100m.

Pseudoadiabatic Chart

- black solid: dry adiabats (constant Θ)
- red solid: water saturation
- red dashed: pseudoadiabats

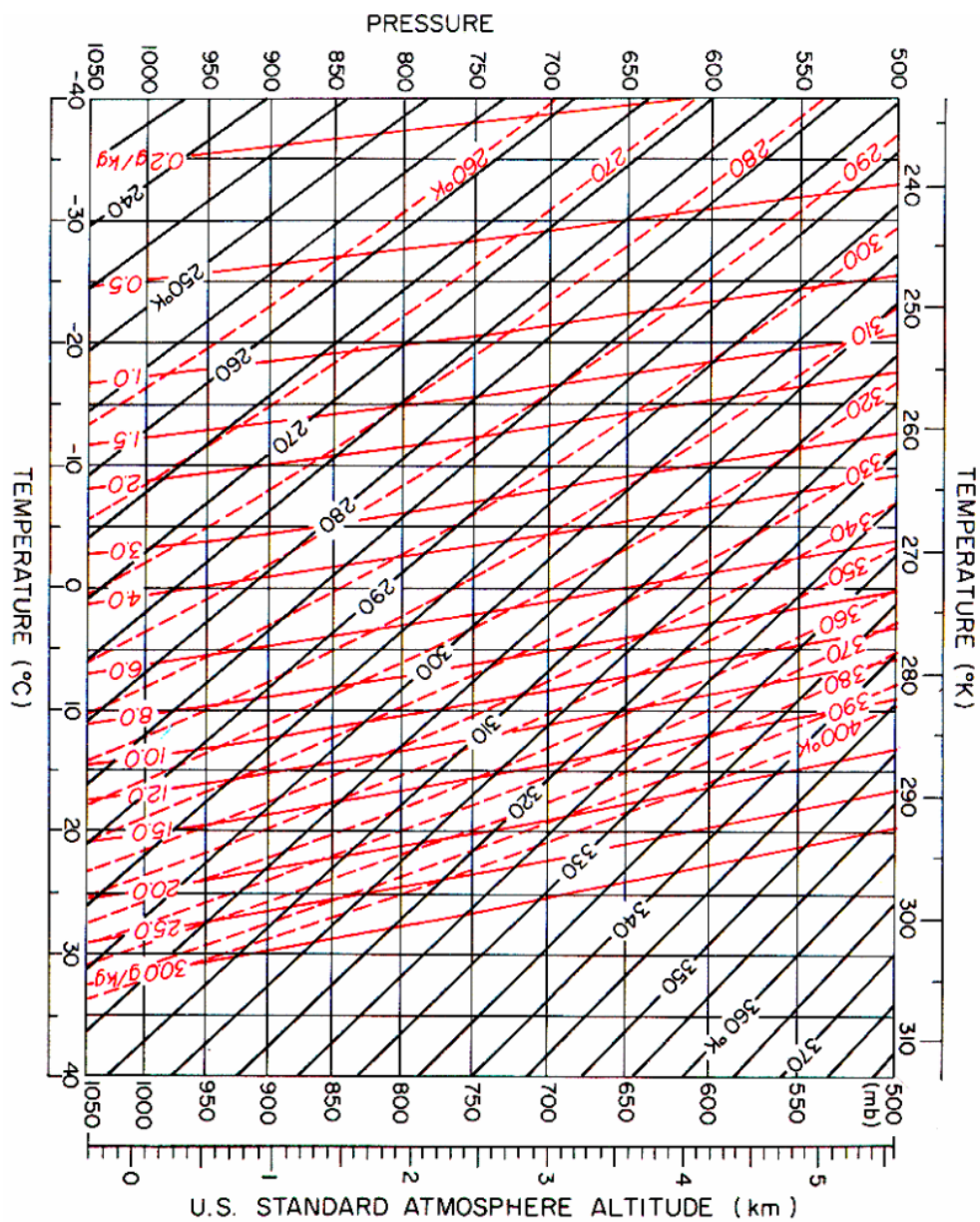

Stability

If a dry air parcel is moved vertically in an atmosphere with an adiabatic lapse rate, its temperature (and thus density) will always be the same as that of its environment (neutral situation).

If the actual lapse rate γ is smaller than the adiabatic lapse rate Γ (T decreasing less with altitude), a parcel lifted will be colder than its environment, which means it is denser and heavier leading to a downward force (stable situation).

If, however, the lapse rate γ in the atmosphere is larger than Γ (T decreasing more rapidly with height), then $T_{\text{parcel}} > T_{\text{enviro}}$ when the parcel is lifted, and thus the density is smaller, leading to an upwards force (unstable situation)

$-\gamma < -\Gamma$ stable

$-\gamma = -\Gamma$ neutral

$-\gamma > -\Gamma$ unstable

Please note the sign convention that might differ in other texts!

As the pseudoadiabatic lapse rate is smaller than Γ , a lapse rate that is stable for dry air can be

unstable for moist air! To assess the importance of this effect, one can evaluate the **equivalent temperature**, which is the temperature an air parcel would have if all latent heat would be converted to heat:

$$T_e = T + w \frac{L_v}{C_p}$$

T_e can be much larger than T and thus at large w air parcels can rise high even in stable situations.

Inversions

If the temperature actually increases with altitude (temperature inversion), the atmosphere is particularly stable and water vapour, aerosols, and pollutants are trapped:

- positive feed back through fog formation
- important for local pollution
- often occurring in high pressure situations when air subsides adiabatically
- particularly persistent in valleys
- boundary layer inversion through accumulation of water vapour and aerosols close to the surface
- nightly inversion through radiative cooling

Foehn

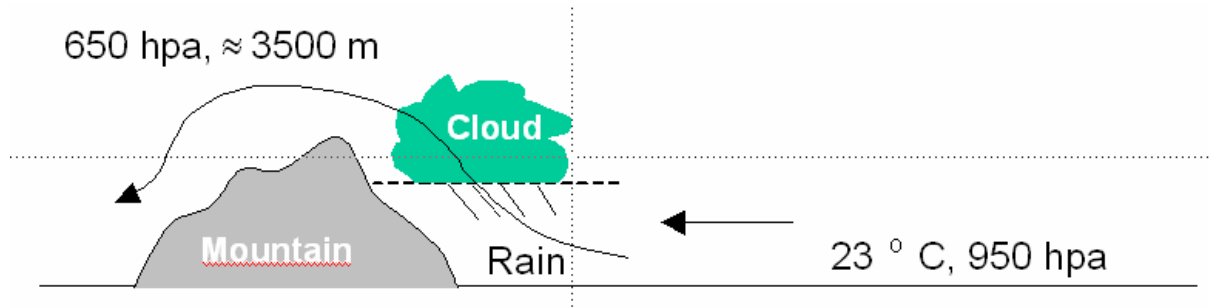

If air is lifted pseudoadiabatically, and all water remains with the air parcel the process is reversible and after evaporation, the potential temperature will be the same as before. However, if water leaves the air parcel (rain), the potential temperature increases permanently and thus the air parcel will be warmer when brought back down to its original altitude.

This explains the Foehn effect in the Alps: air coming from the south is ascending adiabatically until condensation level is reached and continues to rise pseudoadiabatically until it reaches the summit. In this process water is lost through rain. The descent is adiabatic and in effect warm, dry air is observed north of the Alps.

Lee (Gravity) Waves

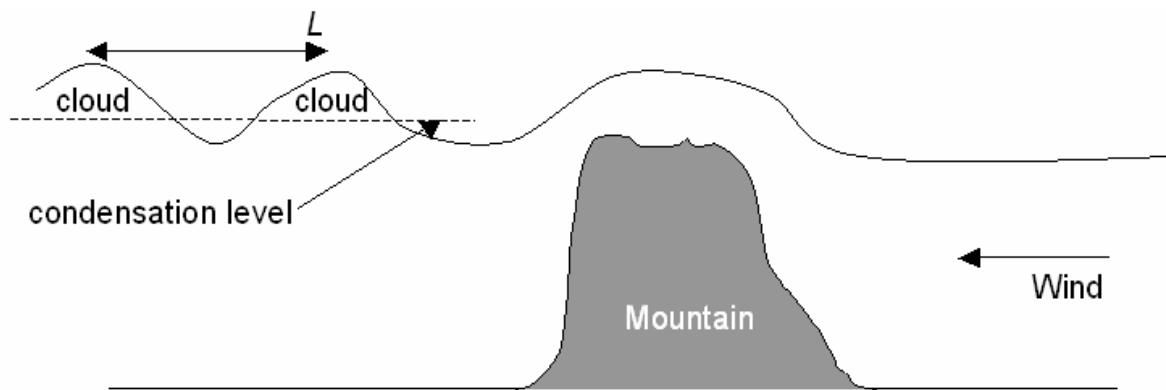

In the lee of mountains, gravity or lee waves form that sometimes can be observed as periodic cloud fields extending long distances after the mountain. We evaluate the force F acting on the air parcel (*) when it is displaced adiabatically from the equilibrium T_0^* by δz :

$$\rho^* \frac{d^2 \delta z}{dt^2} = F = g(\rho - \rho^*)$$

with $\rho \propto 1/T$ we find

$$\frac{d^2 \delta z}{dt^2} = g \frac{1/T - 1/T^*}{1/T^*} = g \frac{T^* - T}{T}$$

The temperature of the air parcel changes adiabatically

$$T^*(z) = T_0^* + \Gamma \delta z$$

while the temperature of the surroundings changes with

$$T(z) = T_0 + \gamma \delta z$$

Thus the temperature difference is

$$T^*(z) - T(z) = (\Gamma - \gamma) \delta z$$

and the vertical acceleration

$$\frac{d^2 \delta z}{dt^2} = g \frac{\Gamma - \gamma}{T} \delta z$$

which is the differential equation of a harmonic oscillator:

$$\frac{d^2 \delta z}{dt^2} + g \frac{\gamma - \Gamma}{T} \delta z = 0$$

The solution is a sinusoidal oscillation with a period T_g of

$$T_g = 2\pi \frac{1}{\sqrt{\frac{g}{T} (\gamma - \Gamma)}}$$

or a frequency $\nu_g = 1/T_g$ of

$$\nu_g = \frac{1}{2\pi} \sqrt{\frac{g}{T} (\gamma - \Gamma)}$$

This frequency is called the **Brunt-Väisälä frequency**. Lee waves form, if the time the air needs to flow around the mountain is similar to T_g .

Thunderstorm Clouds

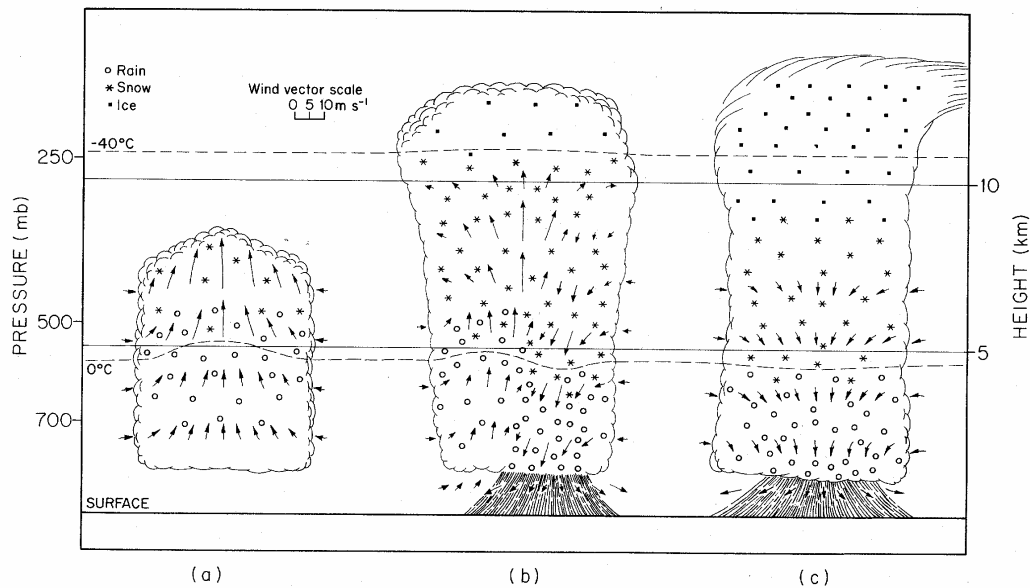

(a) cumulus state

- warm, rising air
- updraft velocities increase with height
- top of cloud moves upwards
- super cooled raindrops in cloud

(b) mature state

- downward circulation of ice crystals, heavy rain
- super cooled rain drops above freezing level, snow and hail below
- top of cloud reaches tropopause, anvil forms

(c) dissipating state

- precipitation throughout the cloud
- no updraft
- no new drop formation

Mid-latitude Clouds

Clouds form in frontal systems when cold and warm air masses meet:

Warm Front:

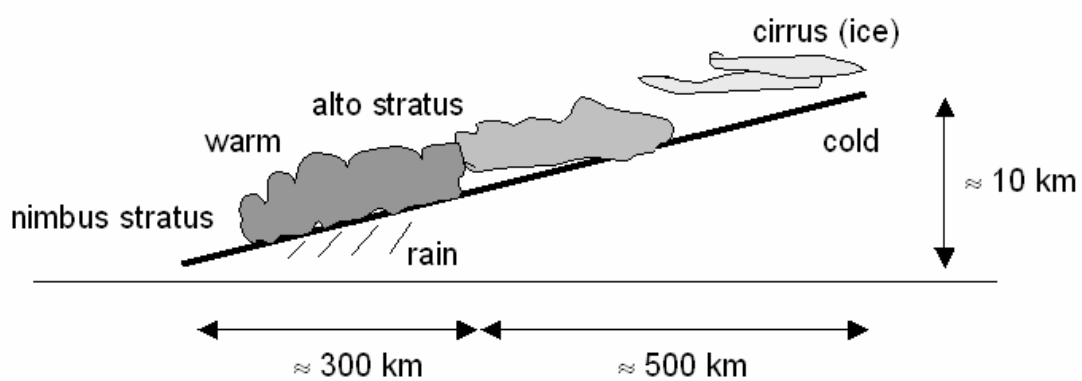

Cold Front:

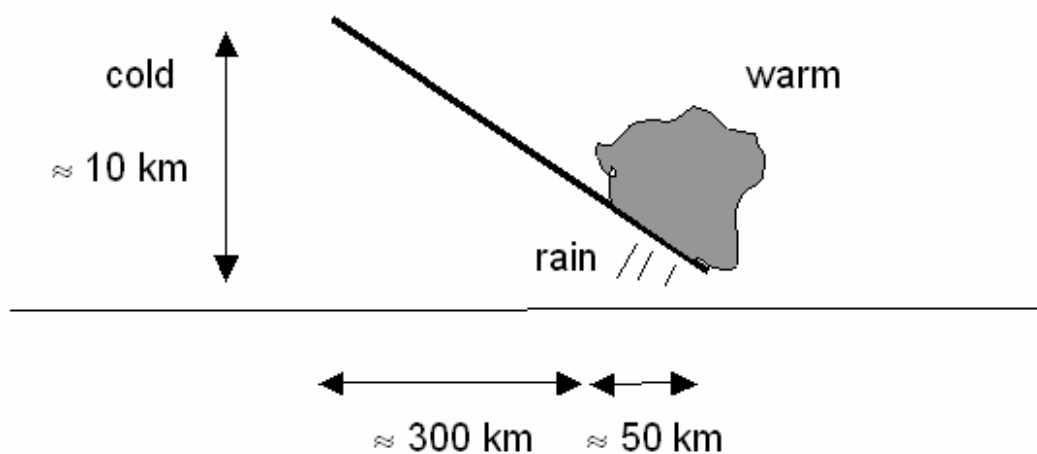

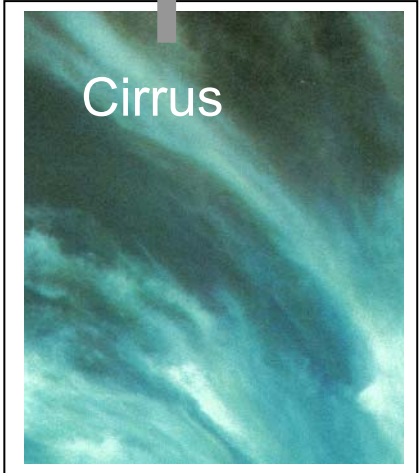
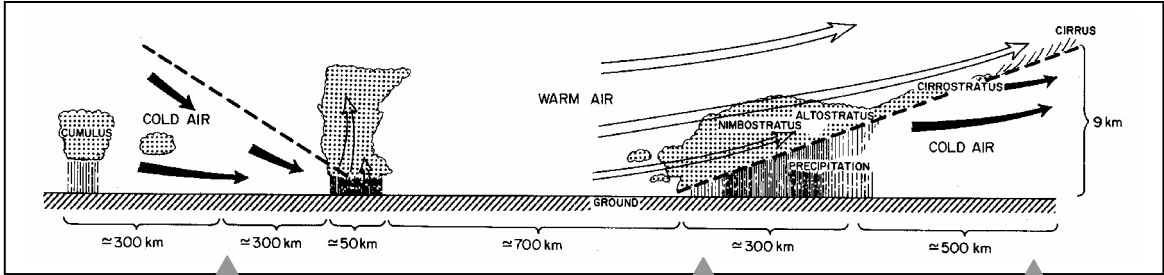

Clouds in the Upper Atmosphere

Polar Stratospheric clouds (PSC):

- form in the polar stratosphere
- important for chemistry (ozone hole)
- consist of ice, HNO_3 and H_2SO_4



Noctilucent Clouds (NLC):

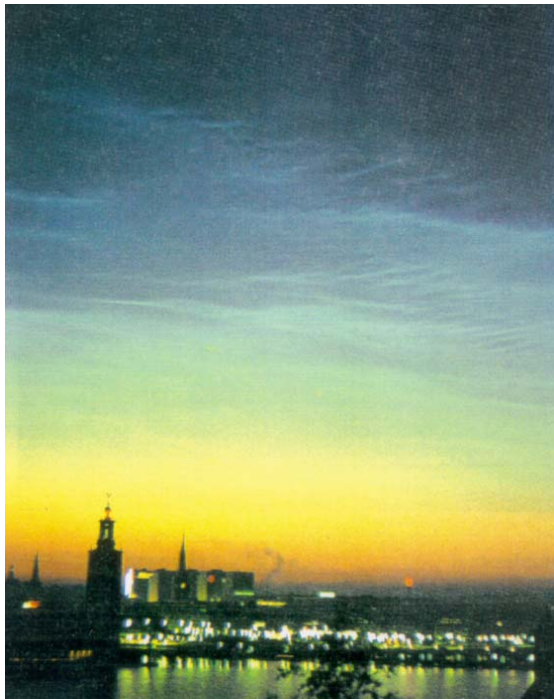

- form in upper mesosphere (> 80 km)
- polar summer
- consist of ice

Condensation

Condensation takes place if the saturation water vapour pressure decreases below the actual water vapour pressure in an air parcel. In the atmosphere, this usually happens through isobaric cooling or adiabatic ascent.

In the absence of particles, condensation proceeds directly from the gas to the liquid phase (**homogeneous condensation**) starting on randomly formed micro-droplets. Homogeneous condensation is rare in the atmosphere as large supersaturations are needed over small droplets.

If wettable or water soluble aerosol particles are present, they act as cloud condensation nuclei and overcome the problem of small droplets (**heterogeneous condensation**). If the aerosol is soluble, the saturation vapour pressure is further decreased and drop growth facilitated.

Homogeneous Condensation

Start with supersaturated air and an embryonic droplet. Condensation

- decreases Gibbs Free Energy ($G = U - TS + pV$) through release of latent heat
- increases Gibbs Free Energy through increase of surface energy of water

From an evaluation of the change in Gibbs Free Energy, **Lord Kelvin** derived the formula giving the vapour pressure over a spherical drop:

$$S = \frac{e_r}{e} = \exp\left(\frac{2M_w\sigma}{\rho_w R T r}\right)$$

- with: e_r = vapour pressure over a drop with radius r
 e = vapour pressure over a flat surface
 M_w = molecular weight of water
 σ = surface tension of water
 ρ_w = density of water
 R = universal gas constant
 T = temperature
 r = radius of drop

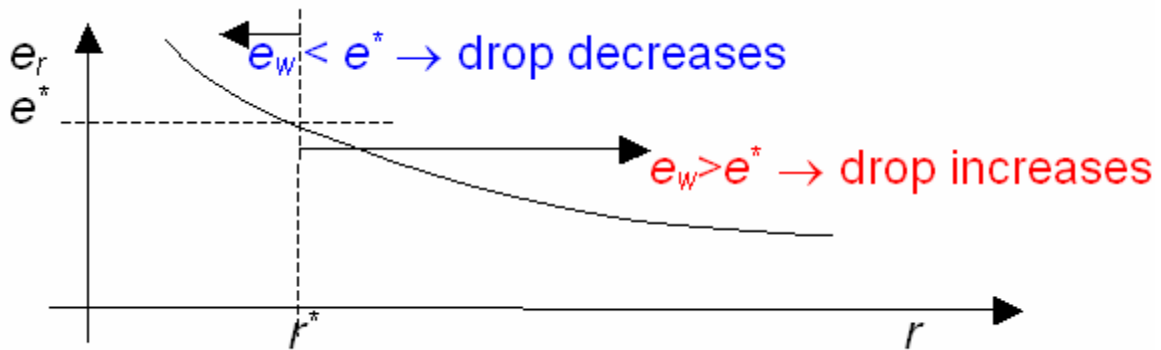

Droplet growth is only possible if the supersaturation over the drop is at least S_{e_s} . For a given supersaturation S^* , a critical radius r^* can be determined above which droplet growth takes place:

$$r^* = \left(\frac{2M_w\sigma}{\rho_w R \ln S^*} \right)$$

The values given in the table show, that typical supersaturations of a few percent correspond to a critical radius that can not be reached by random aggregation of water vapour molecules:

S^*	r^* [μm]	Number of Molecules
1.01	0.115	$2.1 \cdot 10^8$
1.1	0.012	$2.4 \cdot 10^5$
2	$1.65 \cdot 10^{-3}$	630
10	$4.46 \cdot 10^{-4}$	17

=> without importance in the atmosphere!

Aerosols

Sources:

- combustion
- gas to particle conversion (H_2SO_4)
- wind blown dust / sand
- pollens
- sea salt

Atmospheric Relevance:

- scattering (visibility)
- cloud condensation nuclei (CCN)
- climate

Atmospheric Concentrations:

- $10 \dots 10^7 \text{ cm}^{-3}$, decreasing with altitude

Size:

- $10^{-4} \mu\text{m} \dots 10^2 \mu\text{m}$

Sinks:

- gravitational setting
- precipitation (80 - 90%)

Size Distribution:

Often follows a power law

$$\frac{dN}{d(\log D)} = C D^{-\beta}$$

with C the concentration, D the diameter and β in the range of 2 - 4:

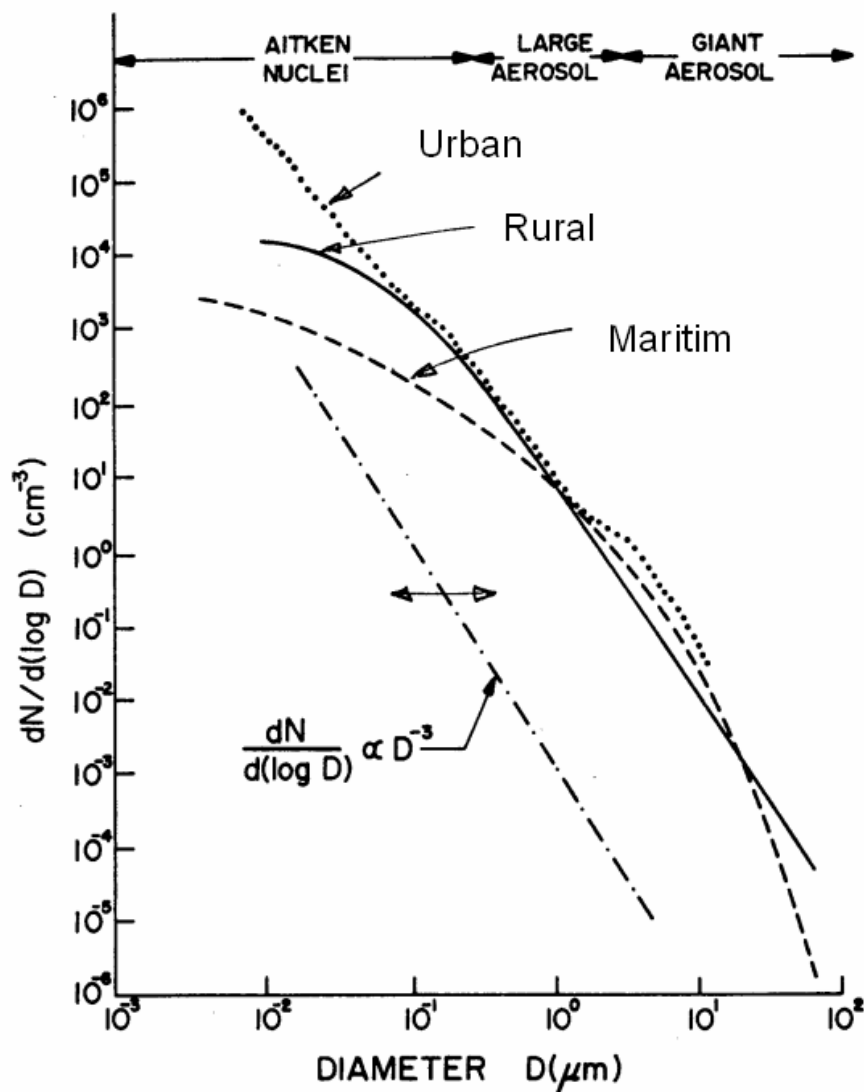

Heterogeneous Condensation

If aerosols are wettable, water vapour can attach to them and droplet growth can start at a radius well above the critical radius for homogeneous condensation. As aerosols are abundant in most places, heterogeneous condensation will always be more probable than homogeneous condensation.

In addition to the size effect, soluble aerosols further reduce the necessary vapour pressure as the vapour pressure over a solvent is smaller than over the pure substance (**Raoult's law**):

$$e' = e N_w \quad \text{with} \quad N_w = \frac{n_0}{n + n_0} \quad \text{the molar fraction}$$

n_0 = number of moles of water, n = number of moles of solute.

With $n \ll n_0$

$$\frac{e'}{e} = 1 - \frac{n}{n_0}$$

Considering the dissociation efficiency i ($i = 2$ for NaCl)

$$n = i N_A \left(\frac{m_s}{M_s} \right) \text{ and } n_0 = N_A \left(\frac{m_w}{M_w} \right)$$

N_A = Avogadro number

m_s = mass of solute

m_w = mass of water

M_s = molecular weight of solute

M_w = molecular weight of water

and approximating the density of the solution by that of pure water ρ_w

$$m_w = \frac{4}{3} \pi r^3 \rho_w$$

we find for the vapour pressure over a solution

$$\frac{e'}{e} = 1 - \frac{3 i m_s M_w}{4 \pi \rho_w M_s} \frac{1}{r^3}$$

Combining Raoult's with Kelvin's law:

$$\boxed{\frac{e_r}{e} = \exp\left(\frac{2M\sigma}{\rho_w R T r}\right) \left[1 - \frac{3 i m_s M_w}{4 \pi \rho_w M_s} \frac{1}{r^3} \right]}$$

The combination of Raoult's law and the Kelvin law leads to the **Köhler curves**:

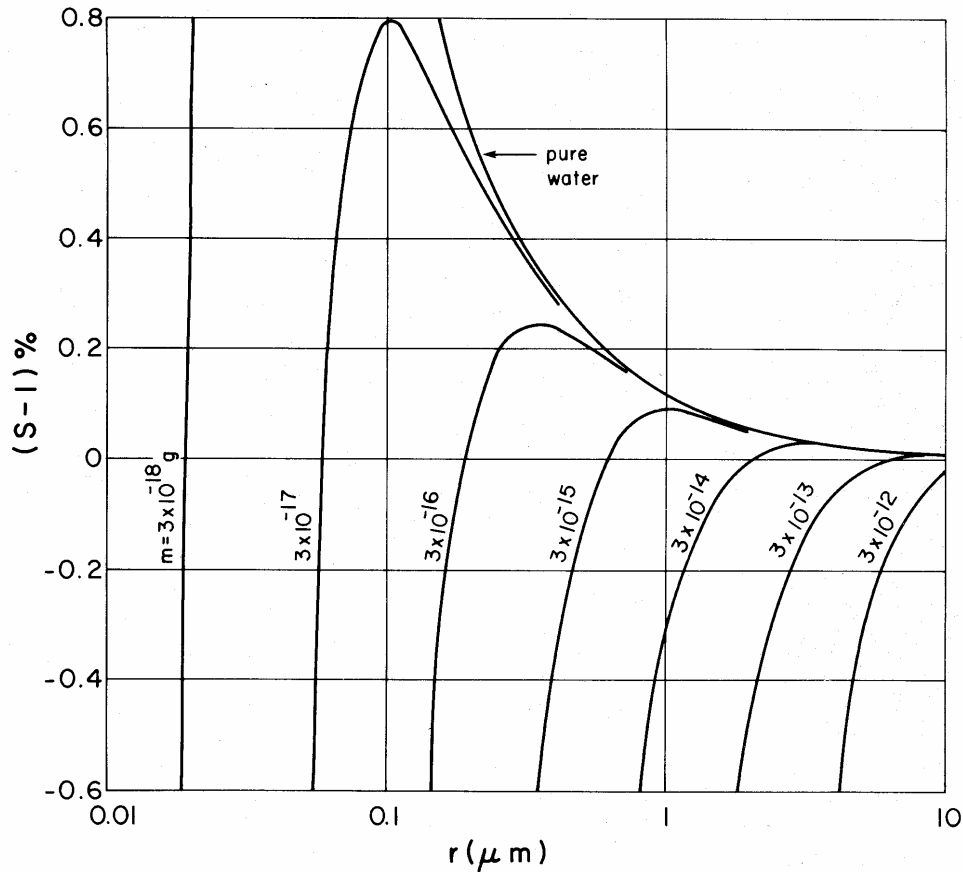

For a given saturation, a small drop will increase according to the Köhler curve. If the saturation is above the maximum of the Köhler curve, the drop will continue to grow, else it will be stable (haze).

A drop with a radius larger than the radius of the maximum of the Köhler curve (typically 0.1 - 1 μm) is called **activated**.

Example:

- assume $3 \cdot 10^{-16}$ g NaCl content in the droplet
- water vapour pressure 0.6% below the saturation over plane water
- => final radius of the droplet $\approx 0.15 \mu\text{m}$
- if a supersaturation of 0.24% or more is assumed, the droplet will grow to $0.2 \mu\text{m}$ where it has reached its critical radius and will continue to grow, this means the particle is activated.

The fraction of activated condensation nuclei is always small ($\approx 200 \text{ cm}^{-3}$) compared to the total number of nuclei which is several orders of magnitude larger.

Droplet Growth by Condensation

As long as water vapour pressure in the air exceeds the vapour pressure close to the droplet, it can grow through condensation. However, latent heat is released close to the drop, increasing temperature and decreasing relative humidity. Thus, drop growth is slowed down depending on the efficiency of heat transport from the drop and the gradient in water vapour pressure:

$$\frac{dr}{dt} = \frac{1}{r} (S - 1) \frac{1}{\underbrace{\frac{RT\rho}{DM_w e} + \left(\frac{L_v \rho_w}{KTM_w} \right) \left(\frac{L_v}{RT} - 1 \right)}_{F^{-1}}}$$

D = the diffusion coefficient

K = heat conductivity of air

L_v = molar heat of vaporization

ρ_w = density of water

Thus, if F and S are assumed to be constant, droplet growth is inversely proportional to the radius.

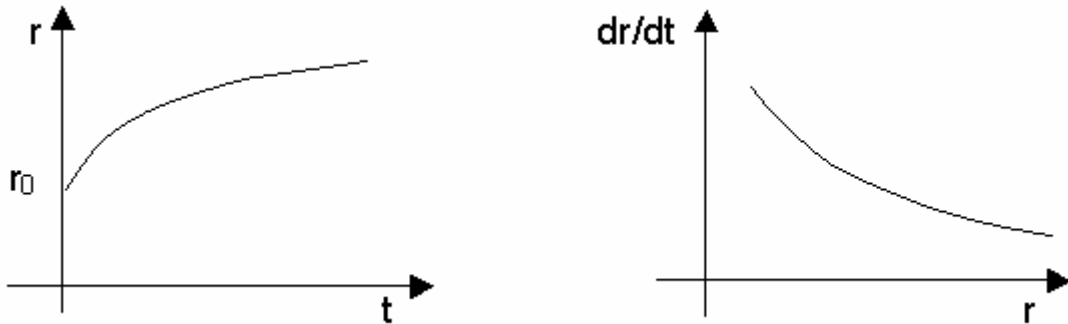

Example:

Assuming for $r_0 = 1 \mu\text{m}$, $F = 1.0 \cdot 10^{-2} \text{ s } \mu\text{m}^{-2}$, and $S = 1.001$ we can estimate the time required for the drop to reach a given radius is:

Radius r [μm]	Time t [s]
5	120
10	500
20	2000

Thus, fast growing clouds such as Cumulus will have a droplet size spectrum different from that of slow growing clouds (Cumulonimbus):

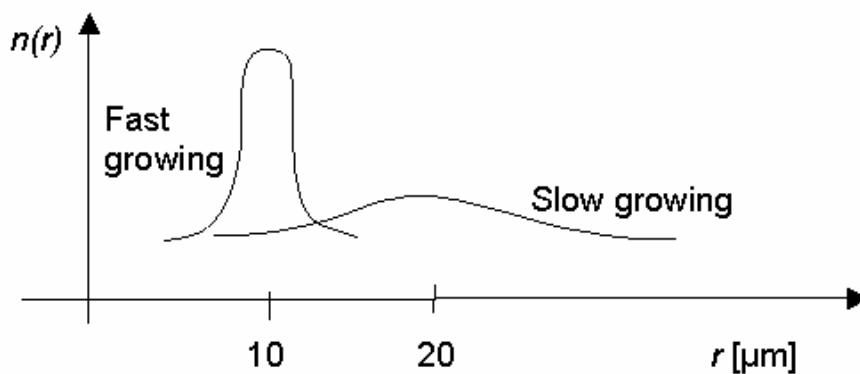

Droplet Growth by Accretion

Droplet growth by condensation would be much too slow for the formation of rain drops of the size of millimetres!

Such large drops form by accretion when faster falling large drops incorporate slower falling small drops.

Falling speeds are difficult to compute; empirical values are:

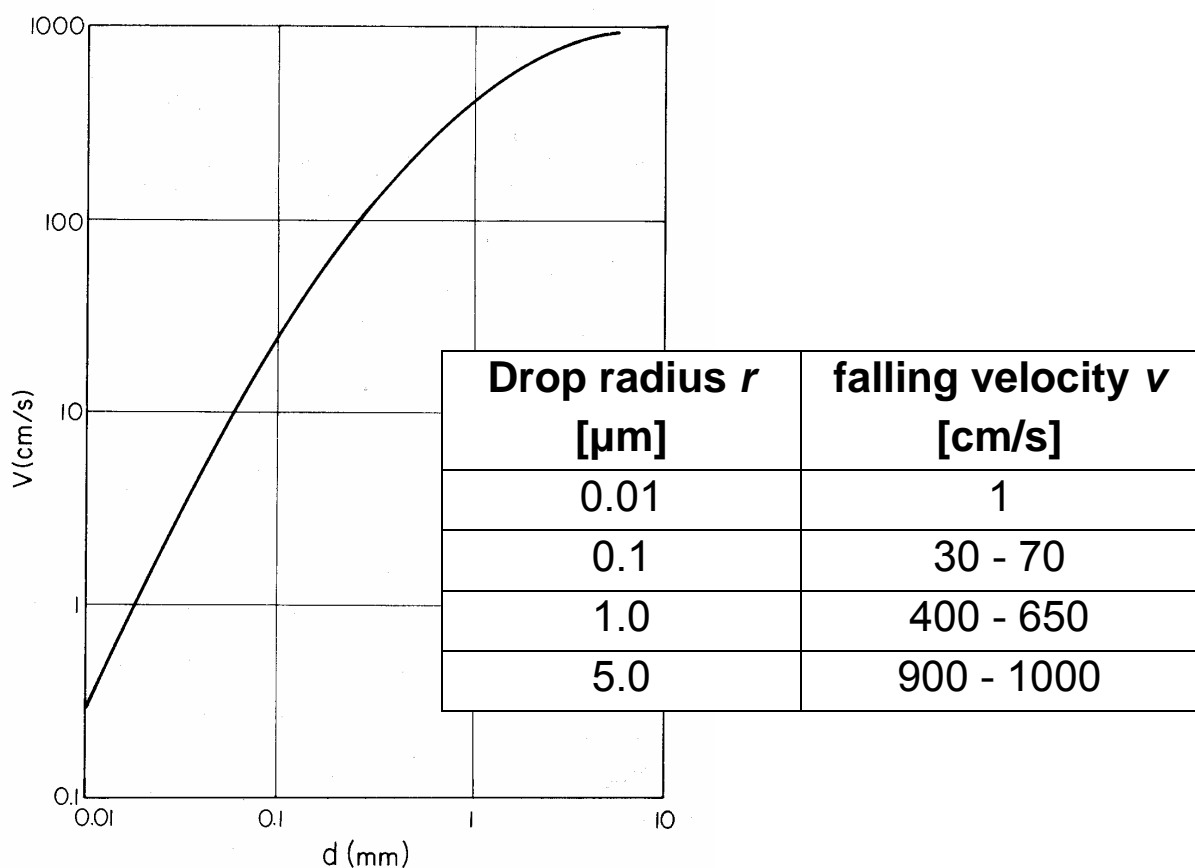

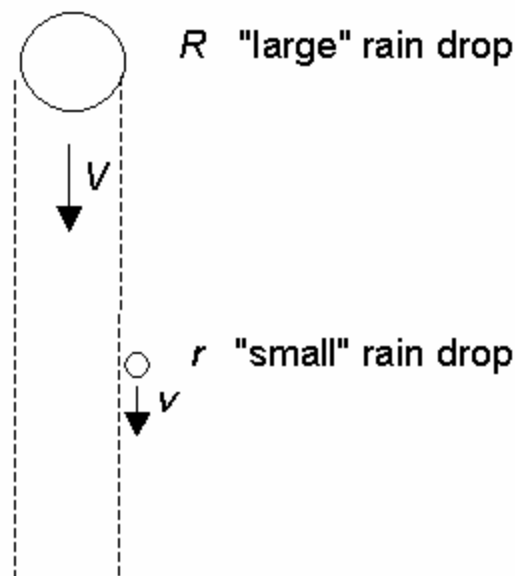

A simple calculation of the mass increase based on geometrical considerations is given by

$$\frac{dm}{dt} = \underbrace{\pi(R+r)^2}_{\text{Area of cylinder}} W \left(\underbrace{V-v}_{\text{differential speed}} \right) E$$

W = total water content of cloud (1g m^{-3})

E = aerodynamics correction factor

$E \approx 1$ for $R > 20 \mu\text{m}$ but decreases rapidly for smaller droplets.

Assuming spherical droplets and $r \ll R$ the size growth dR/dt can be calculated:

$$\frac{dR}{dt} = \frac{1}{4\rho_w} \left(1 - \frac{r}{R}\right)^2 W(V-v)E \quad \text{with} \quad m = \frac{4\pi R^3}{3} \rho_w$$

$$E = 1, \quad r \ll R \quad \rightarrow \quad \left(1 + \frac{r}{R}\right)^2 \approx 1$$

$$\frac{dR}{dt} = \frac{1}{4\rho_w} WV$$

When comparing accretion and condensation efficiencies, the different radii at which they operate become clear:

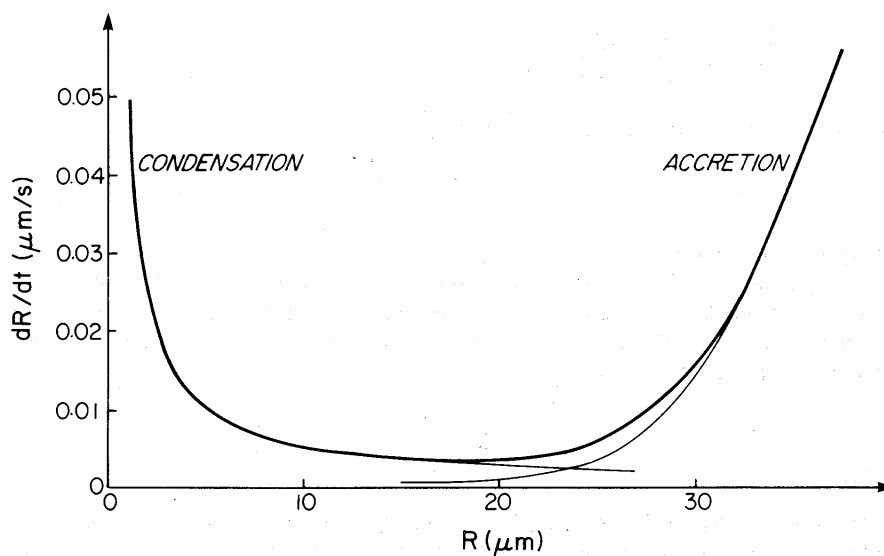

Condensation increases the size of smaller droplets and tends to homogenize the droplet spectrum whereas accretion favours the largest drops and leads to a separation in the droplet spectrum.

Summary of Cloud Droplet Characteristics:

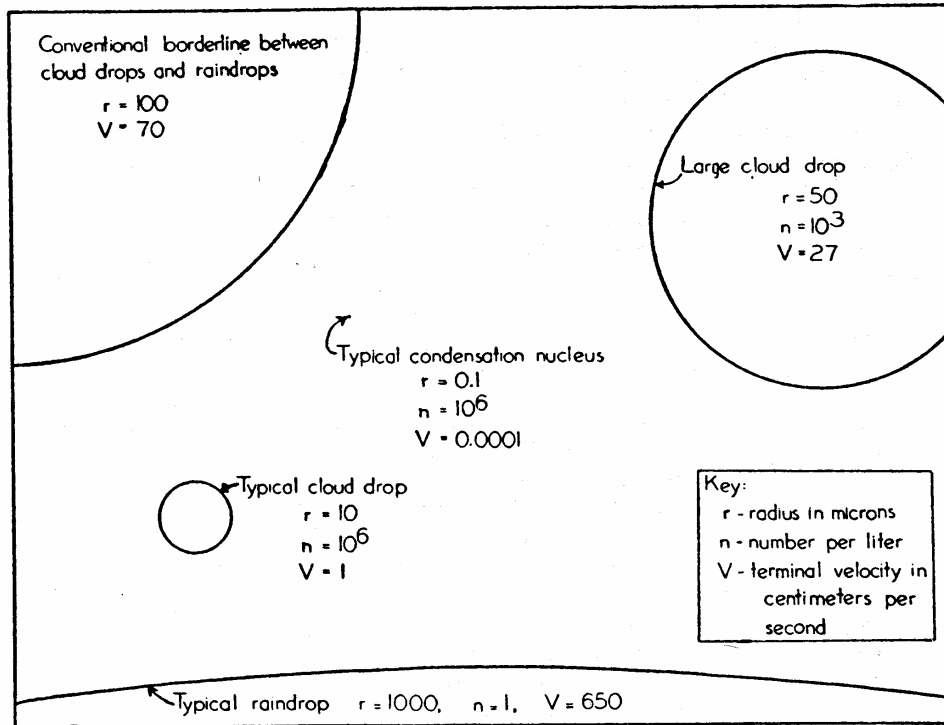

Ice clouds / Findeisen Effect

The situation for freezing is similar to that for condensation, and **homogeneous nucleation** is only realistic below a certain threshold temperature ($\approx -36^\circ\text{C}$). **Heterogeneous nucleation** can occur at much higher temperatures if an appropriate freezing nucleus is available. The latter must have a molecular spacing and crystallographic arrangement similar to ice to be effective.

As water saturation pressure is lower over ice than over water, ice particles will grow at the expense of supercooled water droplets (**Findeisen Effect**).

Ice particles in clouds can grow by

- growth from the vapour phase (Findeisen Effect) => ice crystals
- riming (freezing of supercooled droplets on a falling ice particle) => hail
- aggregation of ice particles

As a result of the geometry of ice particles, quantitative calculations of particle growth are difficult.

Overview over rest of winter term:

Lecture:

7.1., 14.1., 21.1., 28.1.:

Introduction to atmospheric dynamics

4.2.:

Review of concepts

Tutorial:

6.1. submit problems set 8

13.1. submit problems set 9

27.1. submit problems set 10

4.2. Review of concepts

Exam:

16.2., 10:00 - 12:00

- only hand written notes
- no copies / hand-outs / books
- you will be supplied with
 - table of constants and numerical values
 - pseudoadiabatic chart

Forces Acting on Air Parcels

There are basically 4 different forces that act on a moving air parcel in the atmosphere:

- gravitational force
- pressure gradient force
- Coriolis force (when parcel is moving)
- frictional force (when parcel is moving)

There are also two distinct ways of looking at motion in the atmosphere:

- Moving with the air parcel (**Lagrangian Description**). In this description, the atmosphere is a collection of air parcels, all moving with individual velocities as a function of time. This is useful for detailed chemistry modelling and for the assessment of transport.
- Using a fixed coordinate system (**Eulerian Description**). Air properties are described as a function of location \vec{r} and time t , for example the velocity $\vec{v}(\vec{r}, t)$. The observer remains at the same position but air parcels will move by. This approach is useful for large scale models.

Gravitational Force

In first approximation, the gravitational force per volume acting on an air parcel is given by the gravitational acceleration and the mass of the air parcel:

$$\vec{F}_g = \rho \vec{g}$$

ρ = density of air

\vec{g} = gravitational acceleration

To account for variations in gravitation with altitude and latitude we use the geopotential Φ and obtain

$$\vec{F}_g = -\rho \text{grad}\Phi$$

It is important to note, that as a result of the horizontal inhomogeneity of the gravitational field, the gravitational force does not only have a vertical, but also a horizontal component.

Pressure Force

In the presence of a pressure gradient, a force acts on an air parcel:

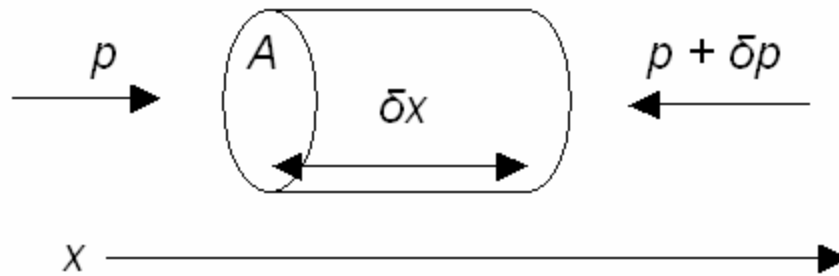

Assuming a pressure gradient in the x -direction, the effective force F_x is acting on the air parcel:

$$F_x = p A - (p + \delta p) A = -\delta p A$$
$$\frac{F_x}{A \delta x} = \frac{F_x}{V} = -\frac{\delta p A}{A \delta x} = -\frac{\partial p}{\partial x}$$

Generalising this to the three dimensional case, we obtain for the pressure force per volume

$$\vec{F}_p = -\text{grad } p$$

Coriolis Force

In a rotating coordinate system, any moving mass that experiences an inertial force that is perpendicular both to the direction of movement and the axis of rotation. This Coriolis force, that is not observed in an inertial system is given per volume by

$$\vec{F}_C = 2\rho [\vec{v} \times \vec{\Omega}]$$

$\vec{\Omega}$ = Earth angular velocity

\vec{v} = velocity of air mass

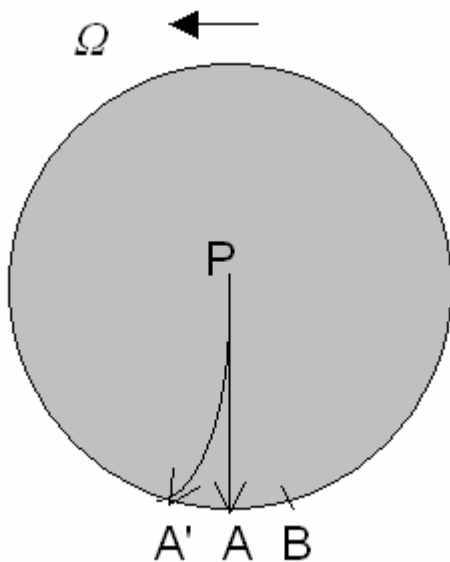

A particle moving from P to A in an inertial system will follow a bent curve from P to A' in the coordinate system of an observer on a rotating disc. He will explain this apparent acceleration by the Coriolis force.

Only the horizontal component of the Coriolis force is relevant in the atmosphere as

- the vertical component is small compared to the gravitational force
- vertical speeds are small compared to horizontal speeds
- the vertical extension of the atmosphere, in particular the troposphere is small

Example: at $v_{\perp} = 5$ m/s and 1000 m vertical movement the Coriolis displacement is only about 20 m

Thus, usually only the horizontal component of \vec{F}_C is treated:

$$F_C = 2\rho v \Omega_{\perp}$$

Ω_{\perp} = vertical component of Earth angular velocity

v = horizontal velocity of air mass

The vertical component of the angular velocity is

$$\Omega_{\perp} = \Omega \sin \varphi$$

with φ the latitude,

$$F_C = 2\rho v \Omega \sin \varphi = \rho v f$$

with $f = 2\Omega \sin \varphi$ the **Coriolis parameter**.

In vector notation and still assuming that there is only one component of the angular velocity

$\vec{\Omega}_{\perp} = (0,0,\Omega \sin \varphi)$ we finally can write

$$\vec{F}_C = 2\rho [\vec{v} \times \vec{\Omega}_{\perp}]$$

- The Coriolis force is pointing to the right in the Northern Hemisphere and to the left in the Southern Hemisphere.
- It is largest at the poles and 0 at the equator.
- At the pole, the acceleration by the Coriolis acceleration is of the order of $2v\Omega = 10^{-3} \text{ m s}^{-2}$ (5 m/s wind speed assumed) which is small compared to g but significant for large movements.

Frictional Force

- Friction will occur within the atmosphere when layers of air move at different velocities or at the ground.
- Friction on the surface depends very much on the surface type (water, desert, forest, ...).
- Friction between layers depends on the speed of momentum diffusion which can be both “thermal” diffusion and turbulent diffusion.
- Frictional forces are always directed against the direction of movement.

In first approximation, one can assume the frictional force per volume to be proportional to the speed:

$$\vec{F}_F = -\kappa \vec{V}$$

κ = friction coefficient

Equation of Motion

The equation of motion following from pressure gradient, gravitation, Coriolis force and friction is

$$\rho \frac{d\vec{v}}{dt} = -\text{grad } p - \rho \text{grad } \Phi + 2\rho[\vec{v} \times \vec{\Omega}] + \vec{F}_F$$

(unit volume, change in momentum equals sum of forces)

The left hand side can be separated in two parts:

- the change in local velocity with time $\frac{\partial \vec{v}}{\partial t}$
- the change in velocity induced by the movement in space to a place where the velocity field has a different value (field

component) $\left(\frac{d\vec{v}}{dt} \right)_{field}$

The latter can for the x-direction be written as:

$$\begin{aligned} \left(\frac{dv_x}{dt} \right)_{field} &= \frac{\partial v_x}{\partial x} \frac{dx}{dt} + \frac{\partial v_x}{\partial y} \frac{dy}{dt} + \frac{\partial v_x}{\partial z} \frac{dz}{dt} \\ &= \frac{\partial v_x}{\partial x} v_x + \frac{\partial v_x}{\partial y} v_y + \frac{\partial v_x}{\partial z} v_z = (\text{grad} v_x) \cdot \vec{v} \end{aligned}$$

or, in a formal notation

$$\left(\frac{d\vec{v}}{dt} \right)_{field} = (\vec{v} \cdot \nabla) \vec{v}$$

Using this notation, we have **Euler's equation of motion:**

$$\rho \frac{\partial \vec{v}}{\partial t} + \rho (\vec{v} \cdot \nabla) \vec{v} = -\text{grad} p - \rho \text{grad} \Phi + 2\rho [\vec{v} \times \vec{\Omega}] + \vec{F}_F$$

Inertia Motion

In the absence of external forces and friction, an air parcel moving at speed v_0 in the atmosphere will not change its velocity. However, the Coriolis force will force it on a circular trajectory if the latitude dependence of Ω is neglected.

In this simplest situation, the equation of motion is

$$\rho \frac{dv}{dt} = \rho \frac{v_0^2}{R} = \rho f v_0$$

$$R = \frac{v_0}{f}$$

R = radius of the motion

The inertia radius R can give an indication for the scales at which the Coriolis force is important. At 5m/s, R varies from 35 km at the pole, 45 km at mid-latitudes and 130 km at 15° latitude.

The time period needed for one complete inertia circle is 12h at the pole and 19h at mid-latitudes. It does not depend on v_0 and R .

Geostrophic Wind

In a slightly less simplified treatment we can look at the situation where friction can be neglected (altitude > 1000 m), and the gravitational acceleration is also ignored. The remaining forces are pressure gradient force and Coriolis force.

The pressure gradient induces an acceleration from high to low pressure, but as the flow accelerates, it is diverted by the growing Coriolis force until the pressure gradient force (PGF) and the Coriolis force balance.

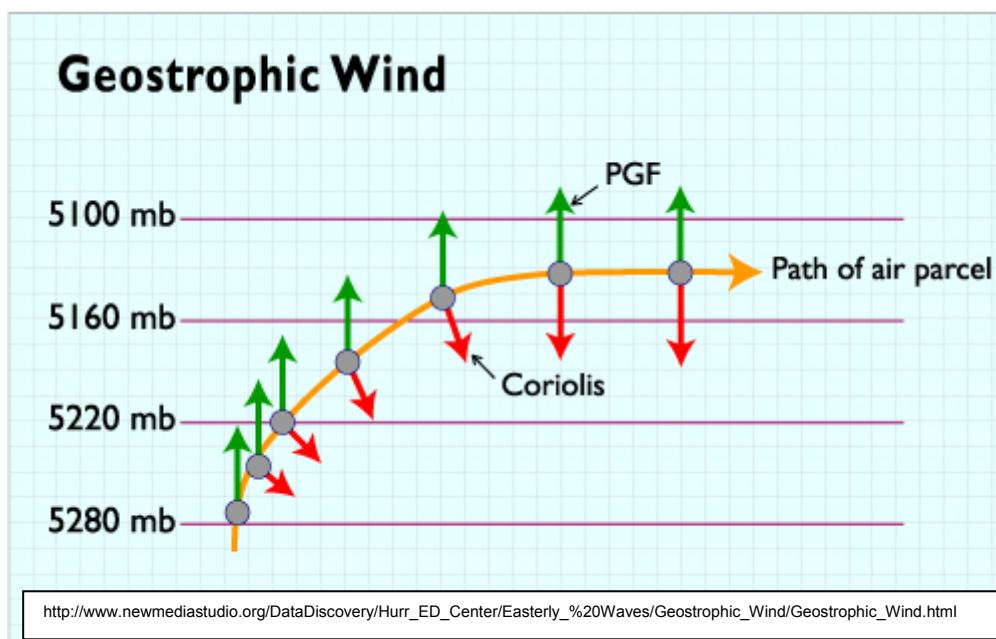

Pressure changes in the atmosphere develop by different heating or cooling, topography, or air movements. They can be either large scale band structures or localized high / low pressure systems.

In the stationary state, the PGF and Coriolis force have identical magnitude but opposite sign:

$$\vec{F}_C = -\vec{F}_p$$
$$2\rho[\vec{v}_g \times \vec{\Omega}] = \text{grad } p$$

or written for the components

$$\rho f v_{gy} - \frac{\partial p}{\partial x} = 0$$
$$-\rho f v_{gx} - \frac{\partial p}{\partial y} = 0$$

yielding for the geostrophic wind vector \vec{v}_g :

$$\vec{v}_g = \begin{pmatrix} -\frac{1}{\rho f} \frac{\partial p}{\partial y} \\ \frac{1}{\rho f} \frac{\partial p}{\partial x} \end{pmatrix}$$

Geostrophic winds can not reduce pressure differences as they are directed perpendicular to the pressure gradient. However, they often are a good approximation for average winds.

If geostrophic winds move air parcels in a region with different pressure gradients, they are no longer in equilibrium. To re-establish equilibrium, the velocity changes and at the same time the air parcel moves towards the high pressure side (and slows down) or to the low pressure side (and accelerates).

In first approximation, geostrophic wind also explains the flow of air around pressure systems:

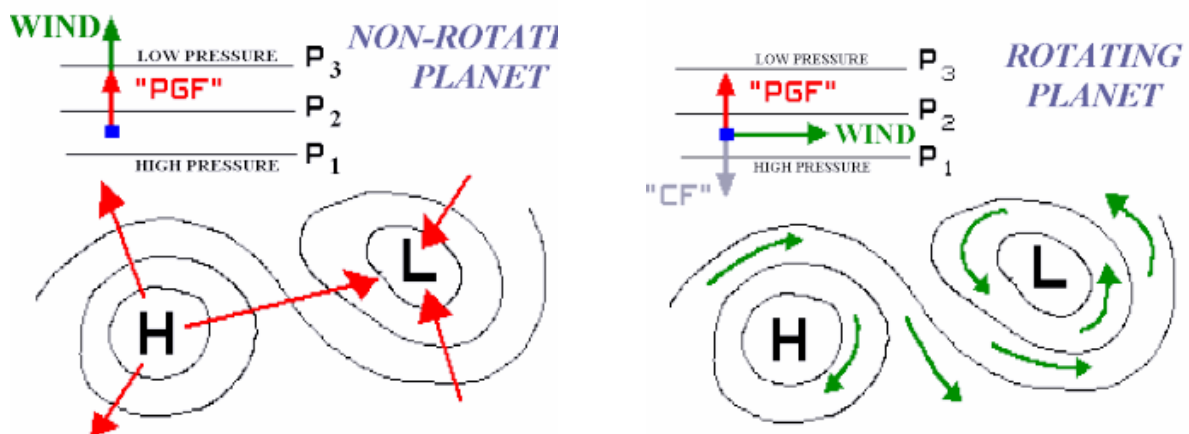

Examples in the Atmosphere

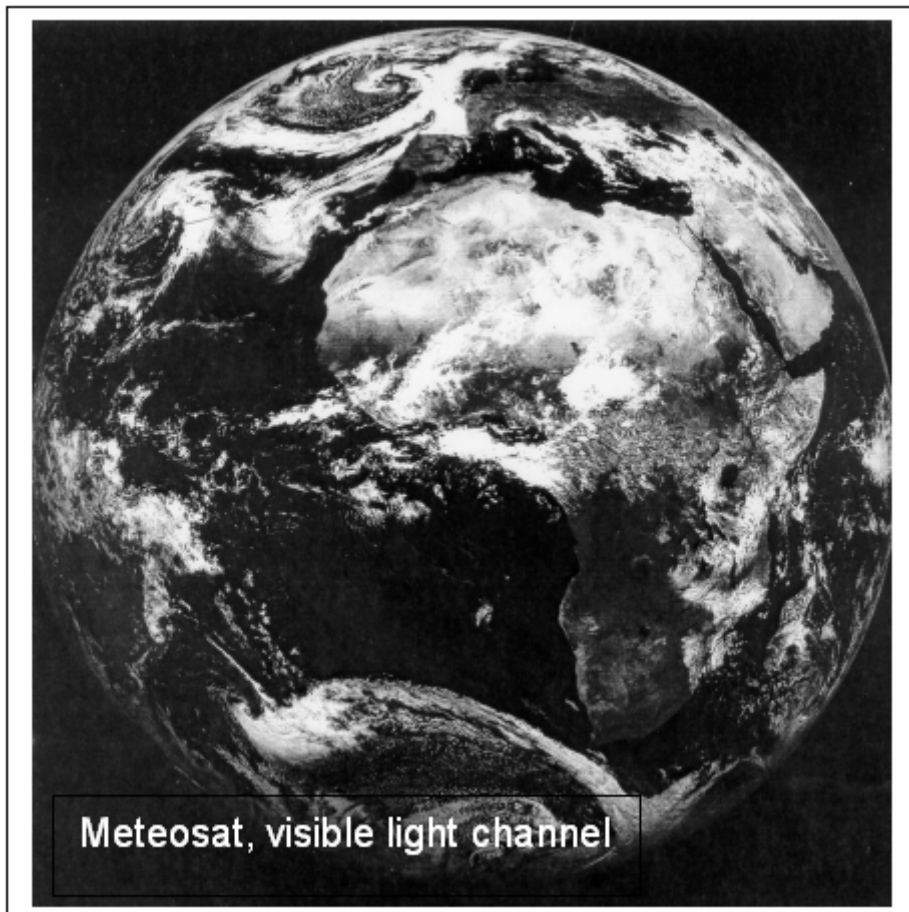
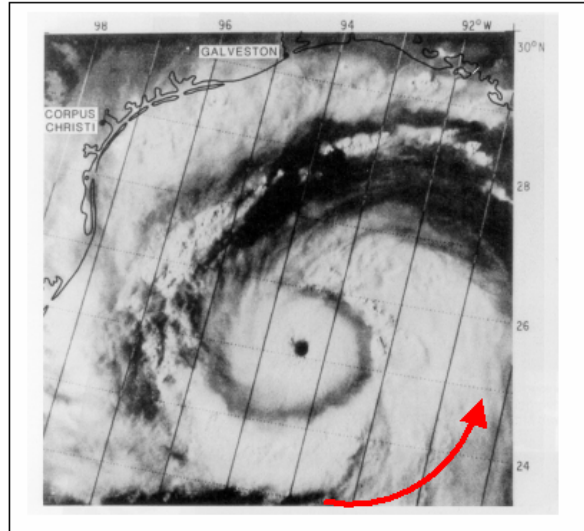
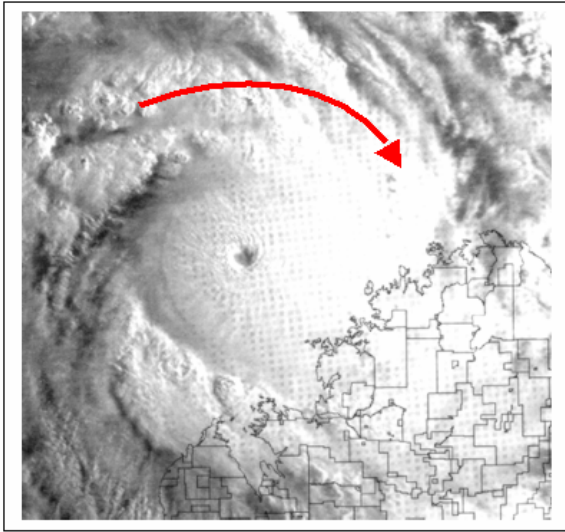

Ekman Spiral

If friction at the surface is taken into account, the wind velocity decreases towards the surface and therefore also the direction of the flow changes from the geostrophic direction in the free troposphere to the surface wind direction. Thus, the wind vector describes a spiral, the Eckman spiral.

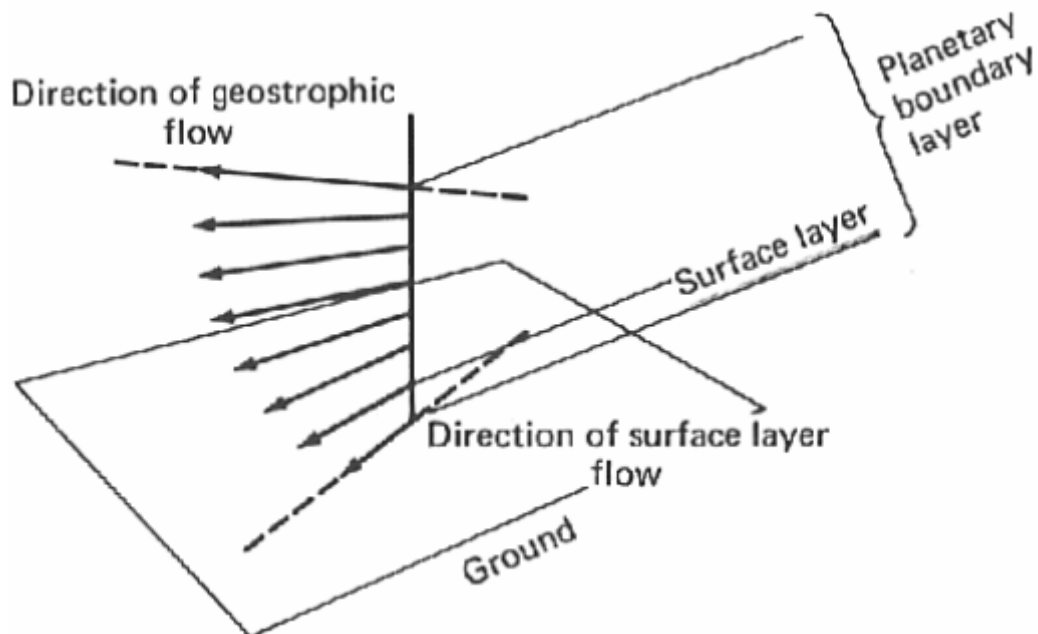

The angle between surface and geostrophic wind depends on surface roughness and is between 10° (smooth surface) to 50° (forests, cities).

With friction, the pressure gradient force is compensated by Coriolis force and frictional force:

$$\vec{F}_C + \vec{F}_F = -\vec{F}_p$$

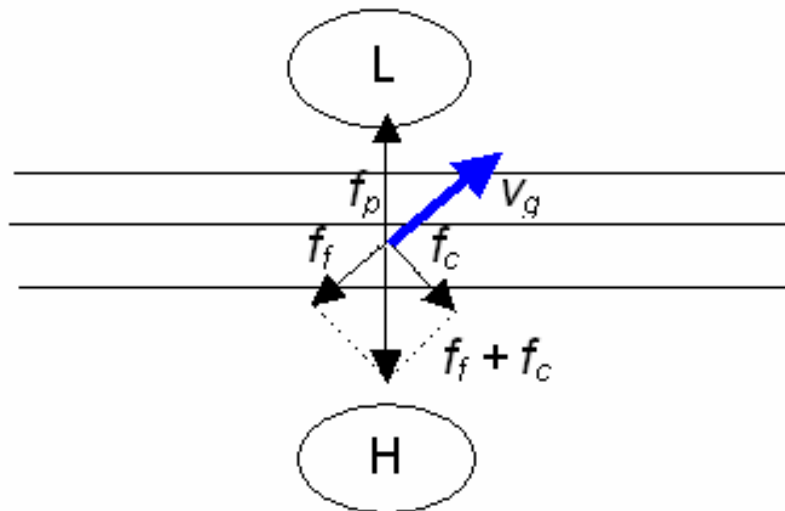

In effect, the Ekman spiral will produce an inflow (convergence) into the low pressure system close to the surface. This inflow will have to be compensated by upward motion and divergence at higher altitudes to guarantee mass conservation.

Thermal Wind

In two air masses with identical surface pressure but different temperatures, the vertical pressure distribution differs as a result of the hydrostatic equation:

$$dp = -\rho \frac{Mg}{RT} dz$$

In the cold air mass, the pressure decreases faster with altitude than in the warm air mass. In the frontal zone in between, the isobaric surfaces are tilted and a horizontal pressure gradient is formed which increases with altitude:

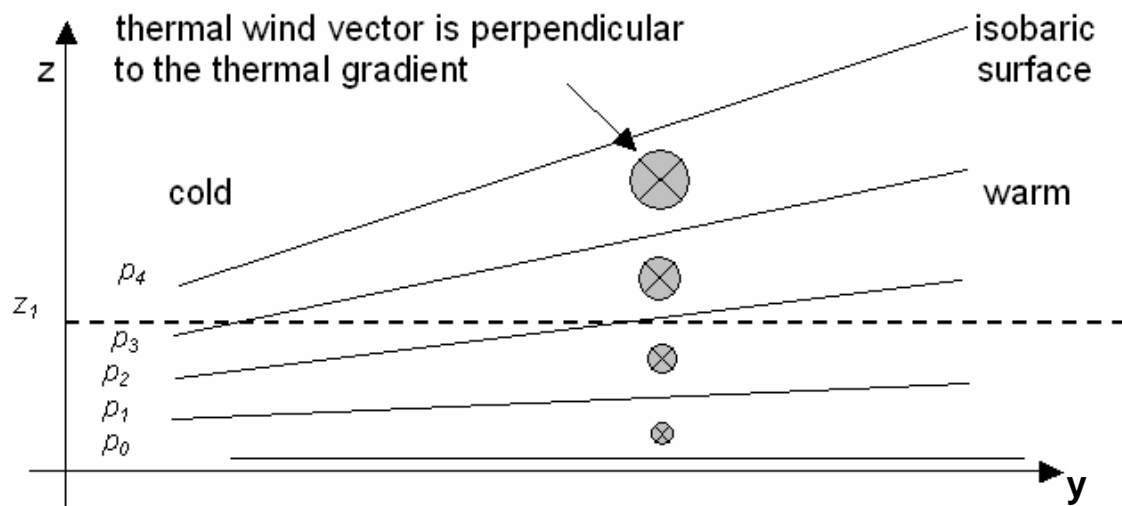

As a result of the pressure gradient, a geostrophic wind forms which is again pointed to the right in the Northern Hemisphere and which increases with altitude as the gradient increases.

Assuming a temperature gradient in the y -direction ($\frac{\partial T}{\partial Y} < 0$), the flow will be in the x -direction, and the change in vertical wind speed can be related to the temperature gradient at the surface:

Hydrostatic equation:

$$\begin{aligned}\frac{\partial p}{\partial z} &= -\rho g \\ &= -\frac{Mgp}{RT} \\ \frac{\partial \ln p}{\partial z} &= -\frac{Mg}{RT}\end{aligned}$$

Geostrophic wind:

$$\begin{aligned}\frac{\partial p}{\partial y} &= -f\rho v_x \\ &= -\frac{Mfp}{RT}v_x \\ \frac{\partial \ln p}{\partial y} &= -\frac{Mf}{RT}v_x\end{aligned}$$

Differentiating again and equating the second derivatives:

$$\frac{\partial^2 \ln p}{\partial y \partial z} = \frac{Mg}{RT^2} \frac{\partial T}{\partial y} = -\frac{Mf}{R} \frac{\partial(v_x / T)}{\partial z}$$

$$\frac{\partial(v_x / T)}{\partial z} = \frac{g}{fT^2} \frac{\partial T}{\partial y}$$

Approximating T by T_m , the mean temperature, we finally obtain

$$\frac{\partial v_x}{\partial z} = \frac{g}{fT_m} \frac{\partial T_m}{\partial y}$$

Thus, if the temperature gradient is known and the velocity at one height, then the vertical profile of velocity can be calculated.

The concept of thermal winds will be used to explain wind systems in mid-latitudes and also stratospheric wind systems.

Up to here, the assumption was made that temperature and pressure gradient are in the same direction (equivalent barotropic atmosphere). In general, the gradients will not be parallel (baroclinic atmosphere). In this situation, the wind direction is derived by vector addition of the geostrophic wind and the thermal wind components:

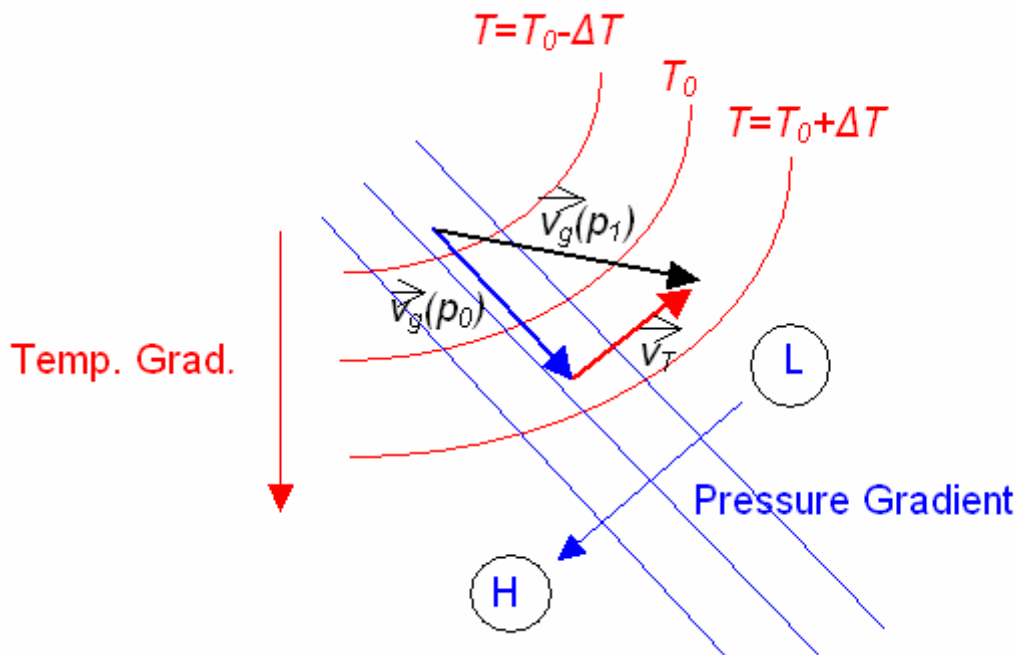

As a result, the geostrophic wind rotates counter clock wise in the situation sketched above (geostrophic wind from cold to warm).

Jet Stream

The thermal wind increases with altitude and is perpendicular to the temperature gradient. In the Northern Hemisphere it has the low temperature (pressure) to the left. Therefore, upper winds in mid-latitudes are dominantly westerly in both hemispheres.

Wind speeds can be high (45 - 70 m/s) and the flow tends to be concentrated in a narrow area where the largest temperature gradient is found (9-14 km, 40° - 60° latitude), the **Polar Jet Stream**. An easterly **Subtropical Jet Stream** also exists at 30° latitude in the winter hemisphere.

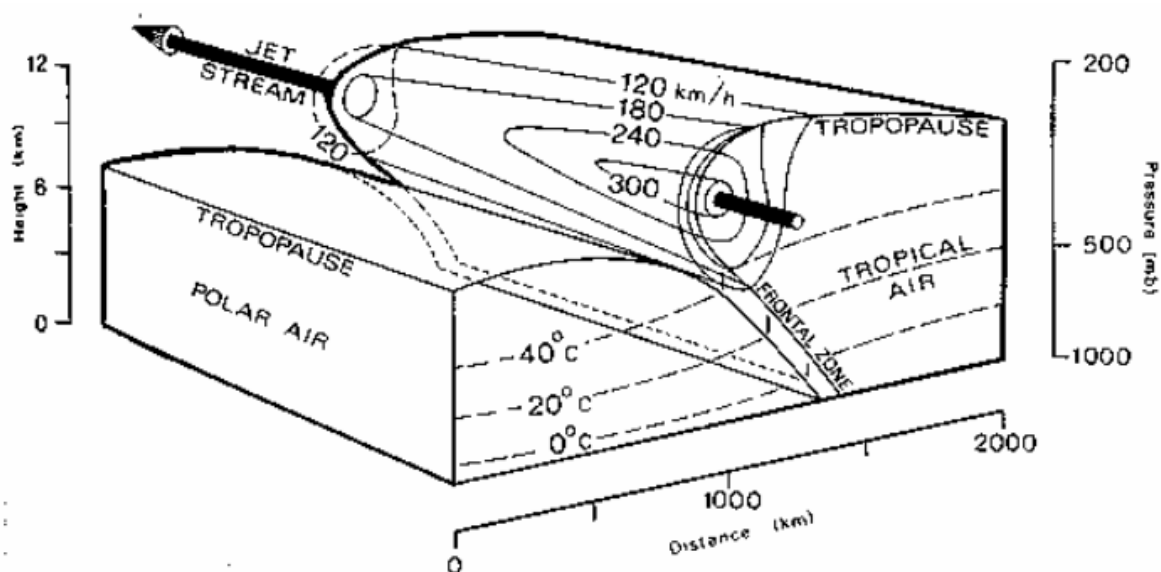

The jet stream is close to the tropopause, and separates warm from cold regions. Depending on surface temperatures, it varies strongly from day to day. It is important for weather, transport and aviation.

Monday, January 12, 2004

JET Stream Winds (KT)

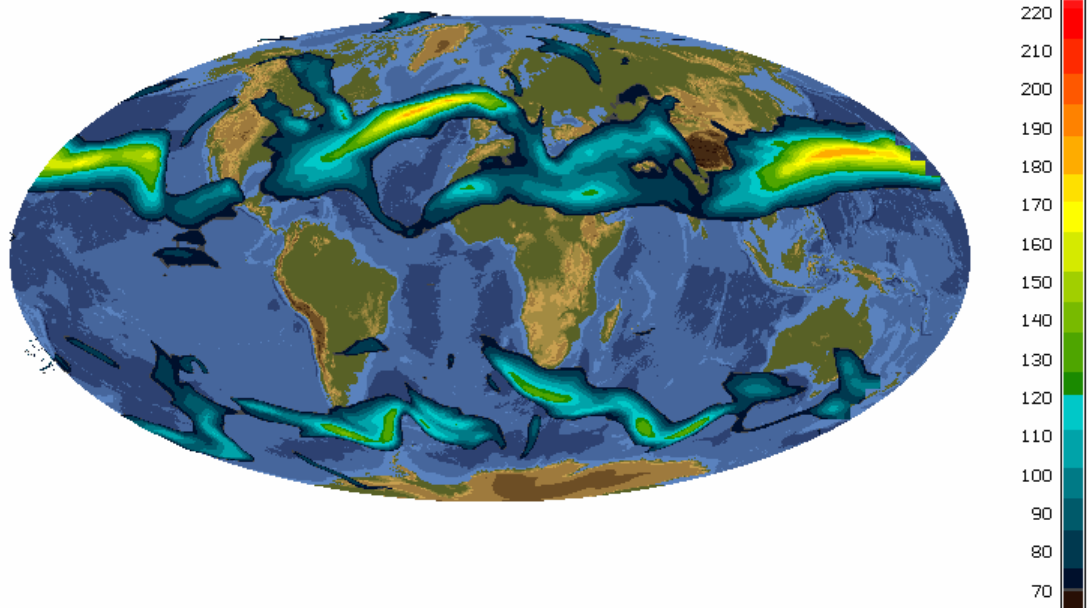

Gradient Wind

Observations show, that near low pressure the wind speed is up to 50% smaller than expected for a geostrophic wind (**sub-geostrophic**). This can be explained by the centrifugal force

$$F_{cc} = \rho \frac{v^2}{R_T}$$

F_{cc} = centrifugal force

v = wind speed

R_T = local radius for the curvature of the isobars

which near the low pressure system acts in the same direction as the Coriolis force but near the high pressure system has opposite direction:

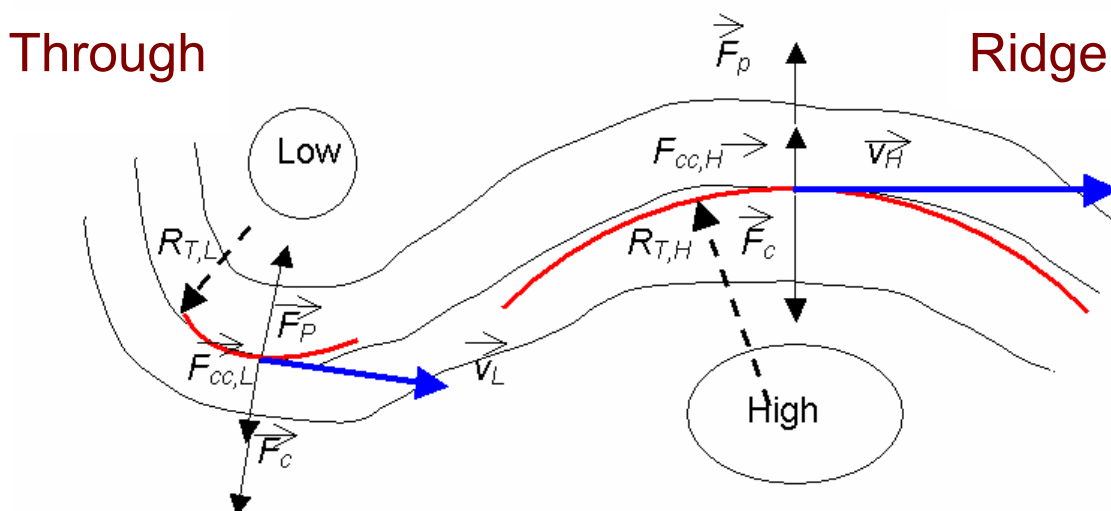

Therefore, wind speed near low pressure are lower and the curvature is smaller than near high pressure.

At low latitudes where the Coriolis force becomes very small we have the so-called **Cyclostrophic Balance** where we find

$$F_{cc} = \frac{\rho v^2}{R_T} \approx F_p \quad \text{with } F_c \approx 0.$$

A good example for this case is a hurricane

Example:

We assume a strong hurricane at 20° north. At 50 km from the centre we have a pressure gradient of 50 hPa per 100 km and assume $\rho = 1.25 \text{ kg m}^{-3}$:

$$|F_{cc}| = |F_p|$$

$$\frac{\rho v^2}{R_T} \approx \frac{\partial p}{\partial x}$$

$$v = \sqrt{\frac{1}{\rho} \frac{\partial p}{\partial x} R_T}$$

$$v = \sqrt{\frac{1}{1.25} \frac{50 \cdot 10^2}{10^5} 50 \cdot 10^3} \text{ m/s} \rightarrow \underline{v \approx 45 \text{ m/s}}$$

Continuity Equation

In the atmosphere, the mass of an air parcel will be conserved. If it is compressed in the horizontal direction, it will expand in the vertical direction. As the troposphere is vertically limited by the surface and the tropopause, a convergence close to the ground will lead to ascent and then divergence at a higher altitude:

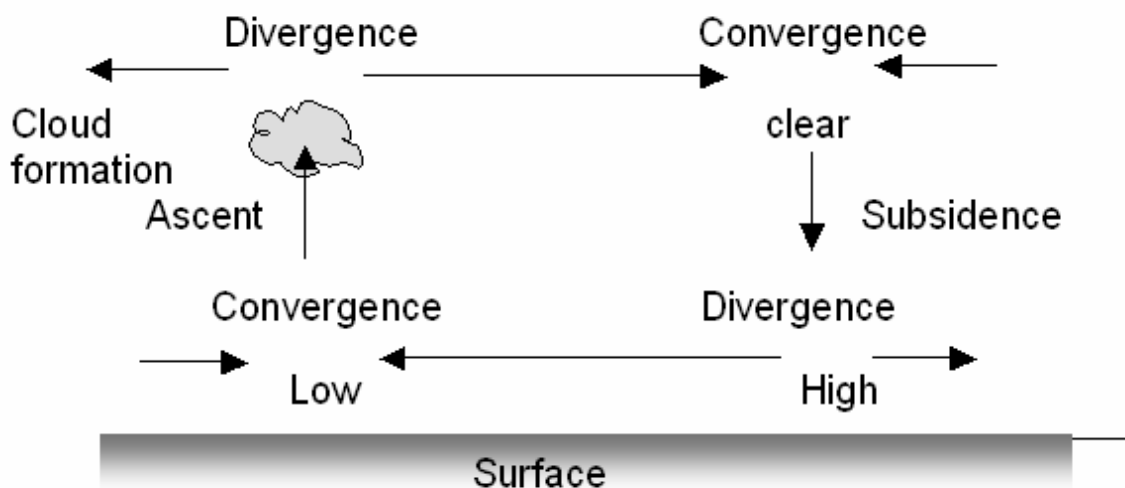

This is a crucial mechanism linking high and low pressure systems to vertical transport and therefore the formation of clouds and precipitation.

The “natural” coordinates for the treatment of continuity are (x, y, p) -coordinates.

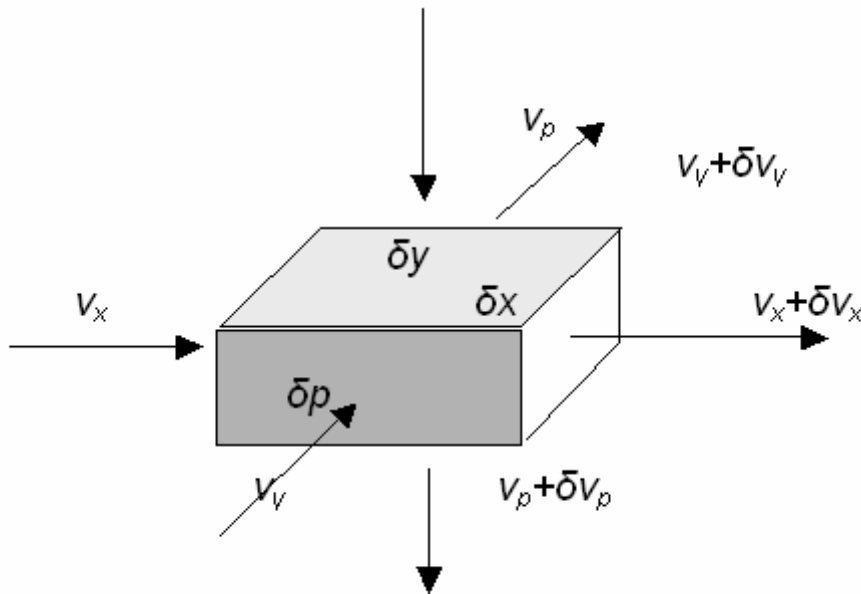

The mass of an air parcel is given by

$$\delta M = \rho \cdot \delta x \cdot \delta y \cdot \delta p$$

As a result of mass conservation, the time derivative can be written as

$$\frac{d}{dt}(\delta x \cdot \delta y \cdot \delta p) = 0$$

$$\delta y \delta p \frac{d}{dt} \delta x + \delta x \delta p \frac{d}{dt} \delta y + \delta x \delta y \frac{d}{dt} \delta p = 0$$

The rate of change of the dimensions of the air parcel can be written as (small air parcel):

$$\frac{d}{dt}(\delta x) = \frac{\partial v_x}{\partial x} \delta x, \quad \frac{d}{dt}(\delta y) = \frac{\partial v_y}{\partial y} \delta y, \quad \frac{d}{dt}(\delta p) = \frac{\partial v_p}{\partial p} \delta p$$

where partial derivatives indicate that the other two dimensions are kept constant. Division by $\delta x \cdot \delta y \cdot \delta p$ yields the continuity equation in pressure coordinates:

$$\boxed{\frac{\partial v_x}{\partial x} + \frac{\partial v_y}{\partial y} + \frac{\partial v_p}{\partial p} = 0}$$

Alternatively, starting again from $\frac{d}{dt}(\delta x \cdot \delta y \cdot \delta p) = 0$

but substituting $\delta x \cdot \delta y = \delta A$, the horizontal area of the air parcel, we obtain

$$\delta p \frac{dA}{dt} + A \frac{d}{dt} \delta p = 0$$

or, after division by $A \delta p$

$$\boxed{\frac{1}{A} \frac{dA}{dt} + \frac{\partial v_p}{\partial p} = 0}$$

Using $\frac{\partial v_x}{\partial x} + \frac{\partial v_y}{\partial y} + \frac{\partial v_p}{\partial p} = 0$ and the definition of the

horizontal Divergence of the wind speed \vec{v} , this can be rewritten as

$$\frac{\partial v_x}{\partial x} + \frac{\partial v_y}{\partial y} = \frac{1}{A} \frac{dA}{dt} = \nabla_H \vec{v}$$

The continuity equation states, that any convergence in the horizontal will result in a divergence in the vertical. A horizontal convergence / divergence can also be visualized as a change in the horizontal area occupied by the air parcel.

For a convergent flow close to the surface and a small vertical velocity at the ground, the continuity

equation predicts a negative $\frac{\partial v_p}{\partial p}$ which is an

upwards velocity increasing with altitude.

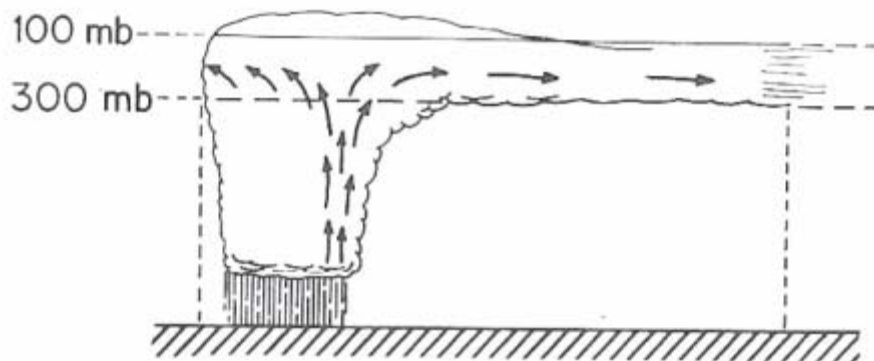
Example:

A large cumulonimbus is observed from a geostationary satellite. From the increase in anvil area (20% in 10 minutes) the vertical velocity at the base of the anvil can be estimated:

$$\frac{dv_p}{dp} = -(\nabla_H \vec{V})$$

Integration from p_1 to p :

$$v(p) = v(p_1) - \int_{p_1}^p (\nabla_H \vec{V}) dp$$

Using the relation between divergence and area change

$$\nabla_H \vec{V} = \frac{1}{A} \frac{dA}{dt} \approx \frac{0.20}{600} \approx 3.33 \cdot 10^{-4} \text{ s}^{-1}$$

and assuming that $v(100\text{hPa}) = 0 \text{ m/s}$, we obtain

$$v_p(300\text{hPa}) = 0 - 3.33 \cdot 10^{-4} \cdot 200 \text{ hPa/s}$$

Assuming a scale height $H = 7\text{km}$, we can finally convert to a vertical velocity v_z averaged over the anvil:

$$v_z(300\text{hPa}) = |v_p(300\text{hPa})| \frac{H}{p} \approx 1.5\text{m/s}$$

Thermal Circulation

If in a hydrostatic situation a differential heating is applied, wind directions in the upper and lower parts of the establishing pressure gradients have opposite directions:

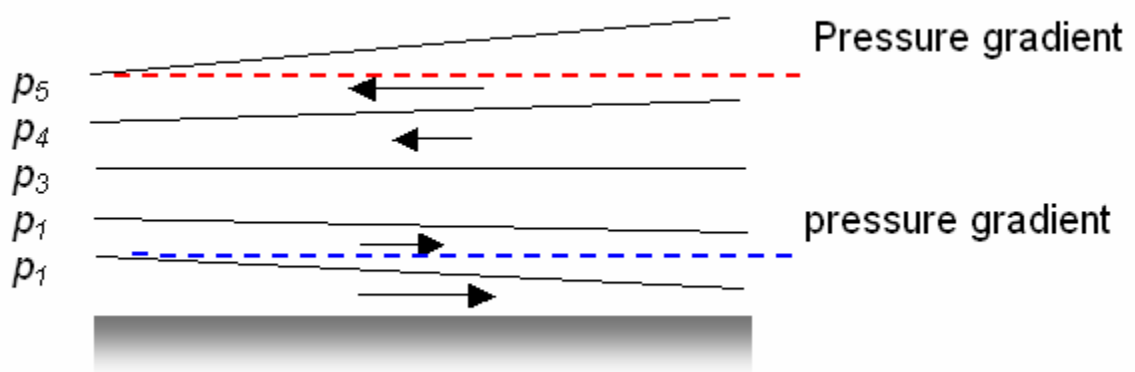

Continuity will lead to an upward motion in the warm region and a downward motion in the cold region. A typical example is sea-land wind that has opposite directions at day and night:

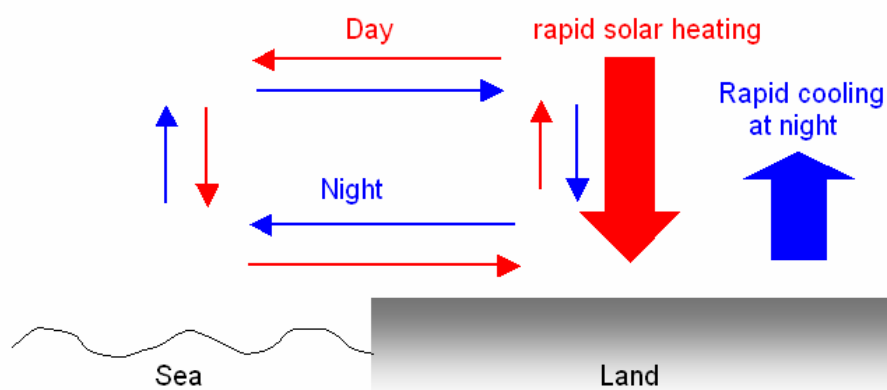

Vorticity

In addition to the equation of motion, the conservation of vorticity is another important basic equation.

Usually, only horizontal motions are treated which have axis of rotation in the vertical. The **Vorticity** ξ then is the vertical component of the curl vector:

$$\xi = \vec{\nabla}_H \times \vec{v} = \frac{\partial v_y}{\partial x} - \frac{\partial v_x}{\partial y}$$

A more general definition based on the circulation Z is

$$\vec{\nabla} \times \vec{v} = \lim_{A \rightarrow 0} \frac{1}{A} \underbrace{\oint \vec{v} d\vec{s}}_Z$$

The sign convention for the vorticity is that it is negative (pointing to the centre of the earth) if the flow is turning clockwise.

In general, two types of flow (or any combination of the two) show vorticity:

- curved flows
- straight flows with horizontal wind shear

Curved Flow:

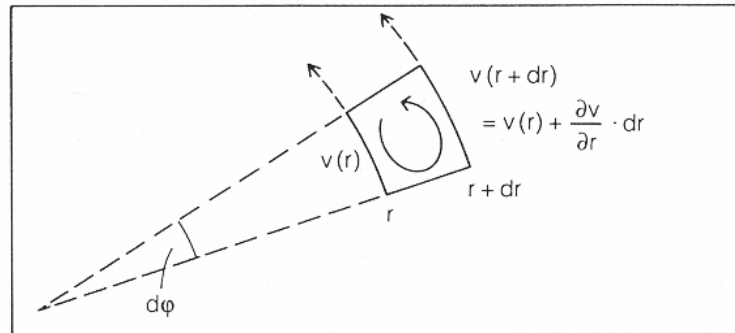

The simplest situation for a curved flow is the rotation, for which the speed is simply

$$v = \omega r$$

The circulation Z can thus be computed as

$$Z = \oint v ds = v 2\pi r = 2\pi \omega r^2$$

Division by the area yields

$$\xi = \frac{Z}{\pi r^2} = 2\omega$$

which is just two times the angular velocity.

For a general curved flow, one can derive that

$$\xi = \frac{v(r)}{r} + \frac{\partial v}{\partial r}$$

Shear Flow:

The basic idea of why a shear flow has a vorticity becomes clear when imagining what the motion of a stick would be in such a flow:

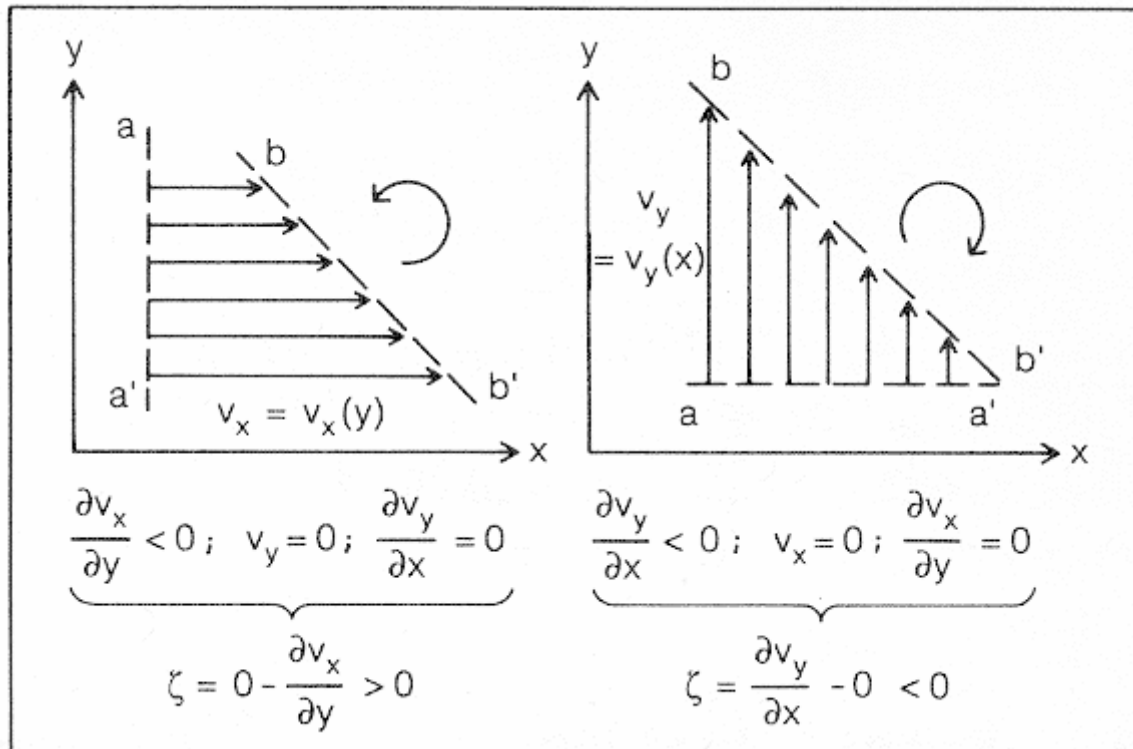

The value of this kind of vorticity follows immediately from the definition in cartesian coordinates.

On the rotating Earth, the **absolute vorticity** η is the sum of the vorticity of the parcel moving in the atmosphere and the vorticity of the rotating Earth:

$$\eta = \xi + f$$

where $f = 2\Omega \sin \varphi$ is the Coriolis parameter and the units are s^{-1} .

On the Southern Hemisphere, the sign of f has to be set to minus $\eta = \xi - f$.

If there are no external forces, the absolute vorticity is conserved, and a continuity equation can be formulated:

$$\frac{\partial \eta}{\partial t} + \eta \text{div}_H(\vec{V}) = 0$$

It should be noted that the vorticity equation is not independent of the equation of motion but can be derived from it by taking the Rotation of both sides and performing some algebra.

Potential Vorticity

A quantity related to the absolute vorticity is the potential vorticity, which combines the conservation of vorticity and mass. The most frequently used definition is that of **Ertel's Potential Vorticity** (PV)

$$Z_E = \frac{\eta}{\rho} \frac{d\Theta}{dz}$$

Θ = potential temperature
 ρ = density

or equivalently

$$Z_E = g\eta \left(-\frac{d\Theta}{dp} \right)$$

The units of PV are $[\text{K m}^2 \text{ kg}^{-1} \text{ s}^{-1}]$, sometimes also abbreviated as PVU.

As long as only adiabatic processes take place, Ertel's PV is a conserved quantity. It therefore can be used as a tracer of air mass origin in the atmosphere.

Potential Vorticity and Polar Vortex

ECMWF PV at 475 K 16.09.02

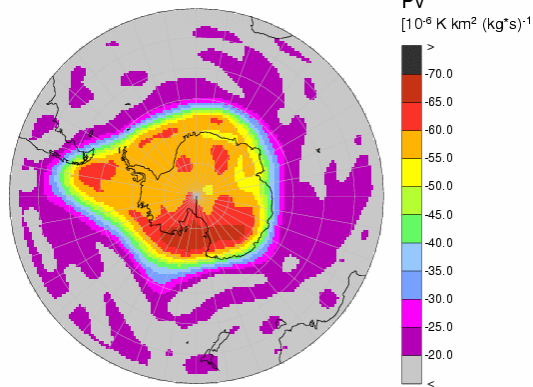
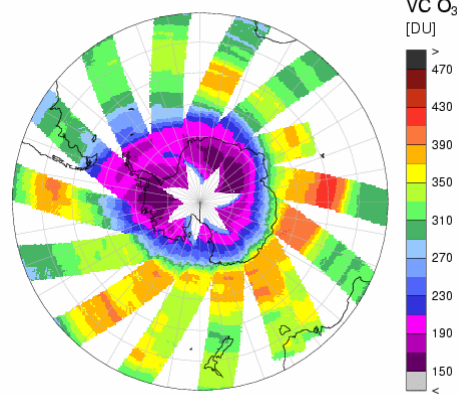
GOME O₃, 16.09.02

ECMWF PV at 475 K 26.09.02

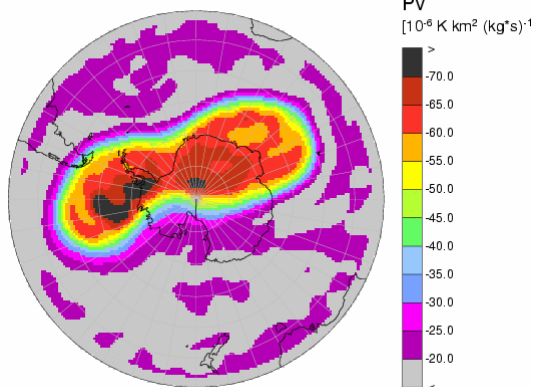
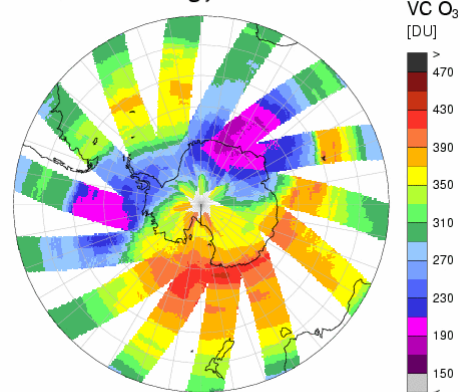
GOME O₃, 26.09.02

In the stratosphere, potential vorticity is a well conserved quantity, and can for example be used to separate air masses of stratospheric and tropospheric origin or air masses from within and outside of the polar vortex.

Application of PV Conservation

An interesting atmospheric implication of the conservation of PV is the anti-cyclonic displacement of a flow over a ridge:

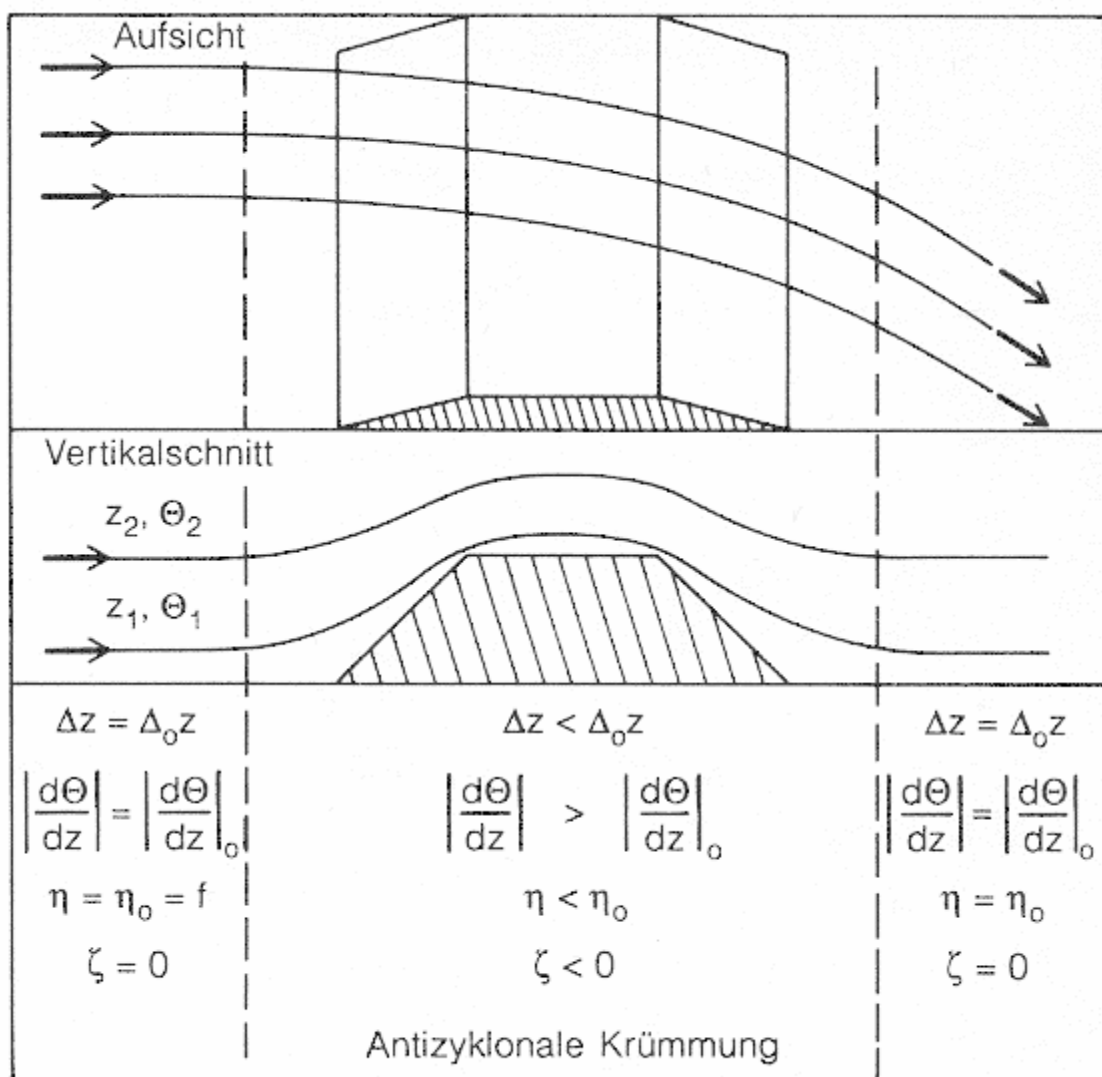

When a parallel flow has to overcome a ridge (mountains, a continent), the distance between levels of potential temperature will be reduced and thereby $\frac{d\Theta}{dz}$ increases. Thus the vorticity η has to decrease. Assuming an initial flow with $\eta = f$ and disregarding changes in f , the flow will get an anti-cyclonic component after the ridge. Under certain conditions, this can give rise to a wave (see discussion of Lee-waves), for example in the Rossby waves.

Rossby Waves

Observation of the polar front shows, that it has an irregular wave pattern with 3 to 5 waves. It also

- seems to have favoured positions for wave formation
- is quite irregular with large excursions to low latitudes and sharp peaks to the pole
- the movement of the large waves and also the high and low pressure systems is in first approximation independent of altitude whereas the wind speed increases with altitude (thermal wind)

The conclusion is, that the structure and speed of the waves is determined by the wind in the middle troposphere where the flow has no divergence and can be considered to be barotropic (density depends only on pressure).

Starting from the vorticity equation and assuming that the divergence is 0, a differential equation can be derived for a horizontal wave, the Rossby wave.

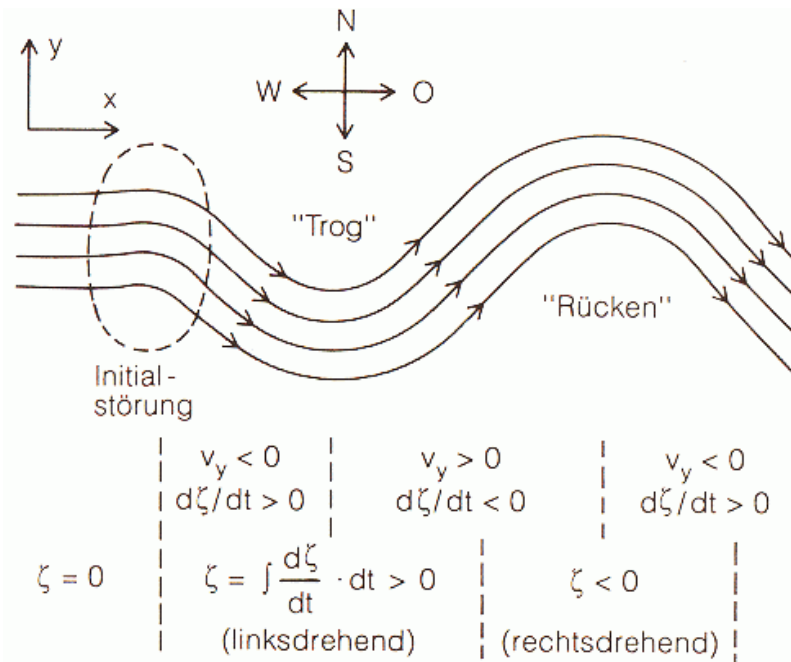

The phase velocity of a Rossby wave is

$$C_{\text{Rossby}} = V_0 - \frac{\beta \lambda^2}{4\pi^2}$$

where β is the change in Coriolis parameter f with latitude:

$$\beta = \frac{df}{dy} = \frac{2\Omega \cos \varphi}{R}$$

For a stationary wave ($C_{\text{Rossby}} = 0$) the wavelength of a Rossby wave is given by

$$\lambda_{\text{Rossby stationary}} = 2\pi \sqrt{\frac{v_0 R}{2\Omega \cos \varphi}}$$

Assuming a latitude of 60° , and a speed of 15 m/s we find $\lambda = 7190\text{km}$ or roughly 3 waves.

Comments on Rossby waves:

- the phase velocity is always smaller than the flow velocity
- larger wavelengths correspond to slower wave speed. In the atmosphere, different wave speeds overlay and therefore smaller waves move through the slower larger waves.
- a very large wave could even proceed in the opposite direction
- Rossby waves are stable, and can not explain the development of cyclones or fronts

Rossby waves can also propagate in three dimensions and link tropospheric and stratospheric dynamics. An important example are major warmings in the stratosphere that can break up the winter polar vortex by dissipating energy in the upper stratosphere and reversing the general flow direction from cyclonic to anti-cyclonic.

Frontal Systems

The interfaces between cold and warm air masses are called fronts. They are regions of strong thermal winds that often extend over hundreds of kilometres.

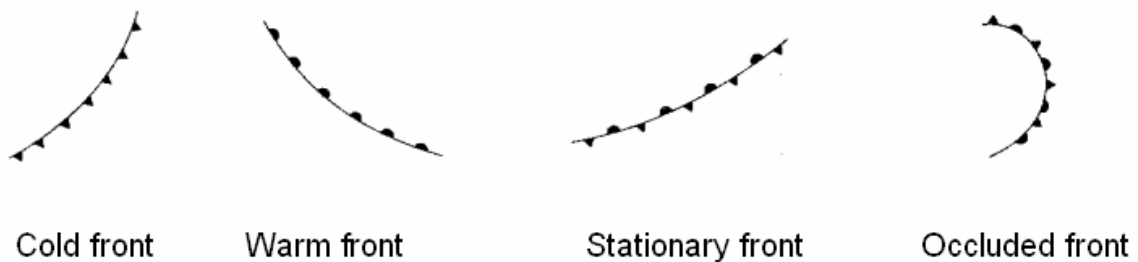

Cold front: cold air advances and pushes warm air up

Warm front: warm air advances and glides on cold air

Stationary front: a front that is not moving

Occluded front: warm air is lifted up by cold air from a fast cold front that is overtaking a warm front

At the polar front, cyclones are generated from instabilities in Rossby waves. They are accompanied by cloud formation, precipitation and strong winds. They also create a net flow of energy from lower to higher latitudes.

Mid-Latitude Cyclone Formation I

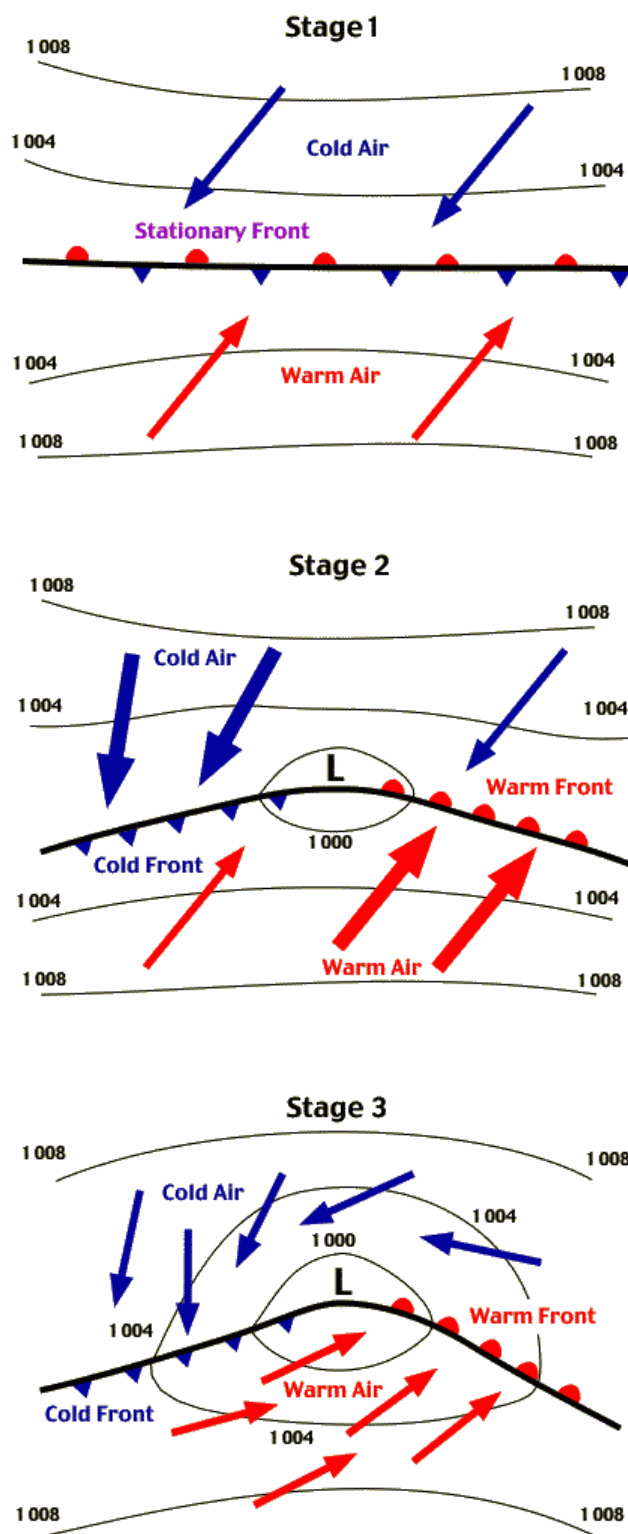

Stage 1:

Weak disturbance of stationary polar front

Stages 2 + 3:

Uplift of warm air creating a low pressure system and cyclonic air flow.

With the flow, warm and cold fronts are created

Mid-Latitude Cyclone Formation II

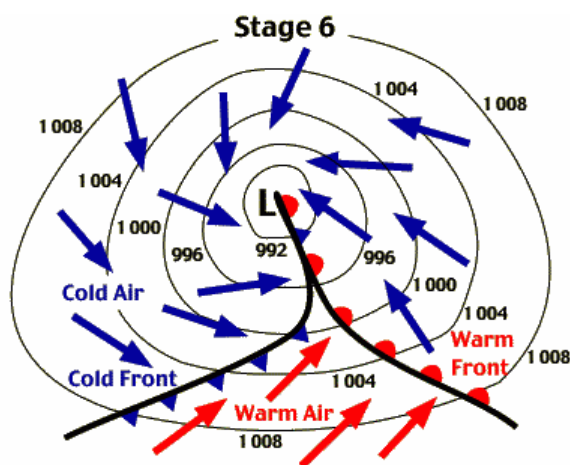
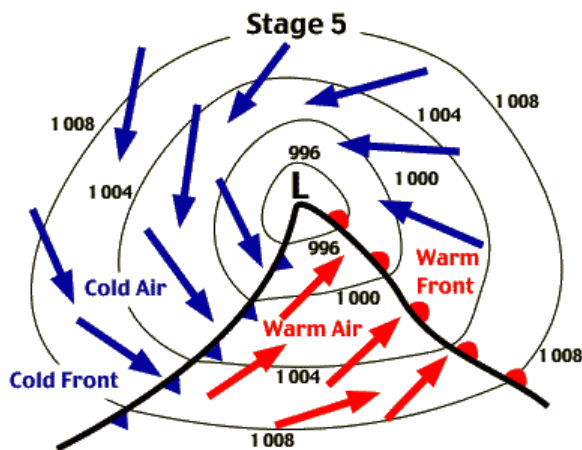
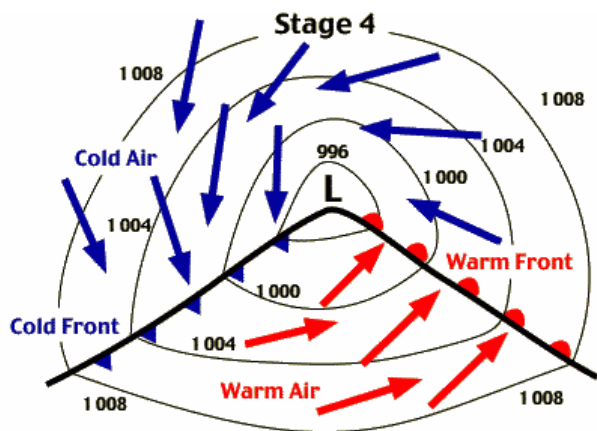

Stages 4 + 5:

Pressure drops and the storm intensifies, the trough gets sharper as wind speeds increase.

Stage 6:

The cold front overtakes the warm front lifting the warm air in the upper atmosphere

Mid-Latitude Cyclone Formation III

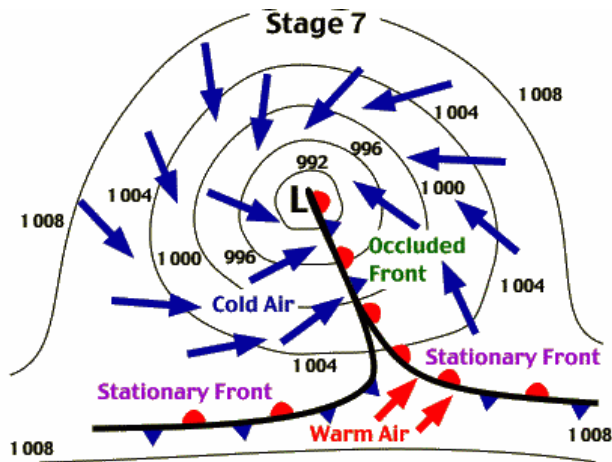

Stage 7:

The uplifting leads to an occluded front

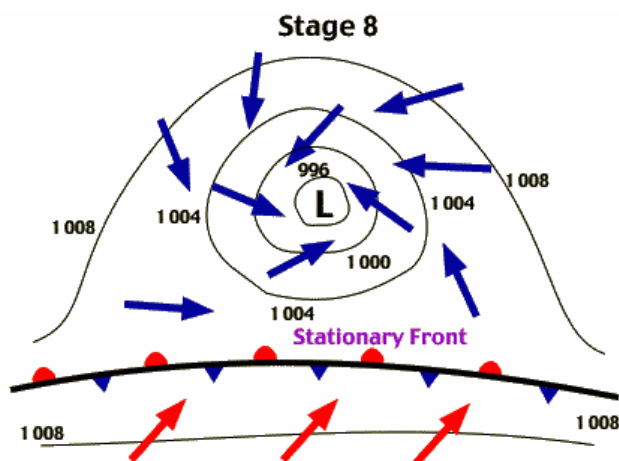

Stages 8 + 9:

The occlusion dissolves, winds subside and the stationary front is reformed. The lifetime of such a cyclone is 3-10 days.

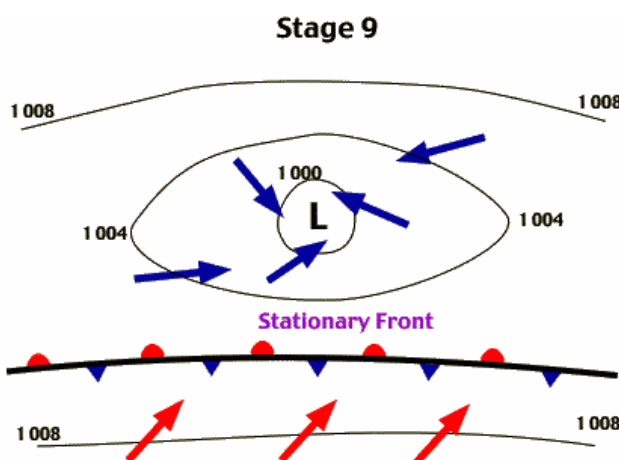

General Circulation

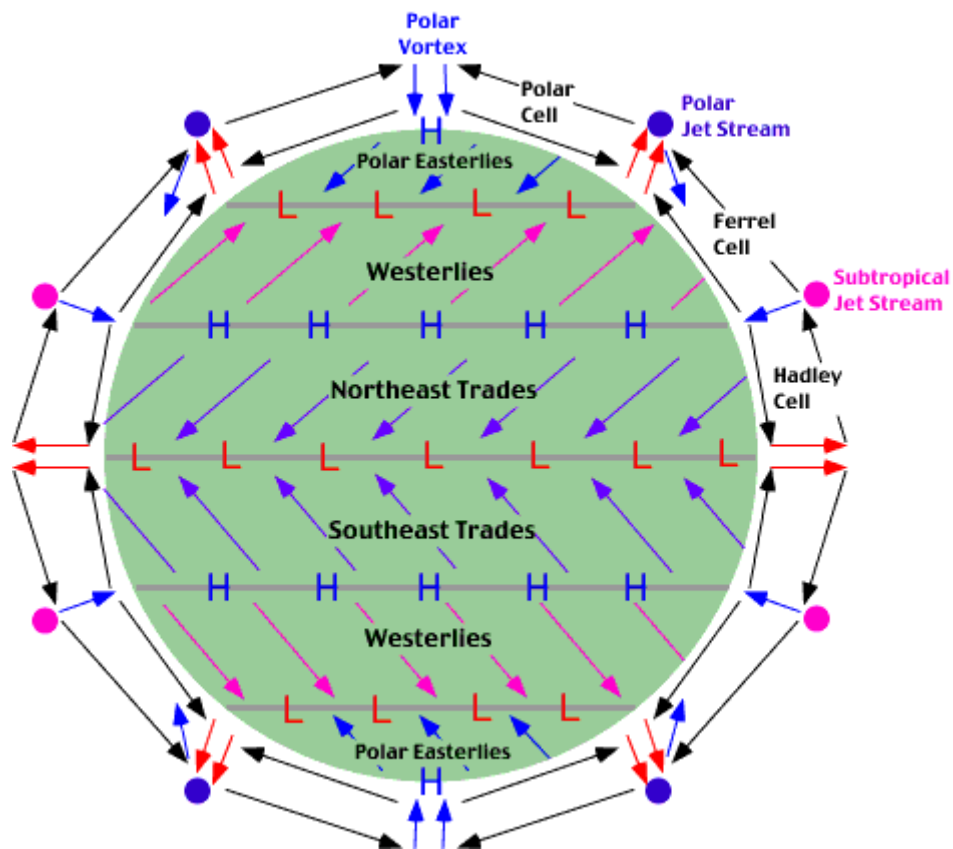

A simplified model of the global atmospheric circulation is based on three cells on each hemisphere which are formed by the stronger heating at the equator, low temperatures at the poles and the deflection of the flows by the Coriolis force:

Hadley Cell	0° - 30°
Ferrel circulation	30° - 60°
Polar Cell	60° - 90°

Hadley cell:

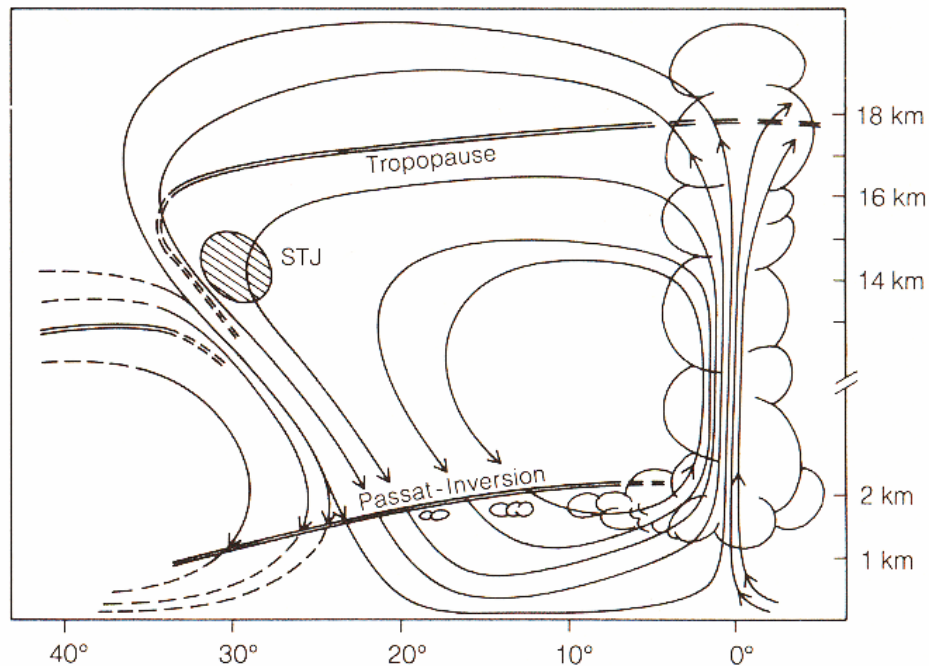

- thermal wind
- convection / convergence leads to rising air over the tropics (ITCZ)
- movement to higher latitudes
- deflection by Coriolis force
- formation of subtropical jet stream (STJ)
- accumulation through transport leads to sinking air at 30°
- formation of subtropical high
- most air moves back to equator close to the surface to close the cell
- again: deflection by Coriolis force => trade winds

Eastward velocities in the upper part of the Hadley cell can be quite large as a simple estimate from angular momentum conservation shows:

$$L = J(\Omega + \omega) = \text{const}$$

$$L = (R \cos \varphi)^2 [\Omega + v / (R \cos \varphi)] = \text{const}$$

L = angular momentum per mass

J = moment of inertia

ω = angular velocity relative to the earth

φ = latitude, R = earth radius

Starting with a flow at the equator ($\varphi = 0$) with no zonal velocity component ($v = 0$) we obtain

$$R^2 \Omega = R^2 \cos^2 \varphi [\Omega + v / (R \cos \varphi)]$$

or

$$v = \frac{R \Omega (1 - \cos^2 \varphi)}{\cos \varphi} = R \Omega \sin \varphi \tan \varphi$$

With $R \Omega = 40000 \text{ km/day} \approx 450 \text{ m/s}$ the eastward velocity at 30° is about $v = 130 \text{ m/s}$.

Measured wind speeds are lower on average (20 - 50 m/s depending on season) but can reach 100 m/s in the subtropical jets.

Ferrel circulation:

- only exists in averaged winds
- high pressure systems tend to form in the subtropics while low pressure systems tend to be located at the polar front. In low pressure systems air ascends while it descends in high pressure systems, horizontal winds balance => on average, a cell is formed
- the Ferrel circulation is thermally indirect

Polar Cell

- thermally direct
- driven by cold surface winds from the poles to mid-latitudes
- wind deflection by Coriolis force

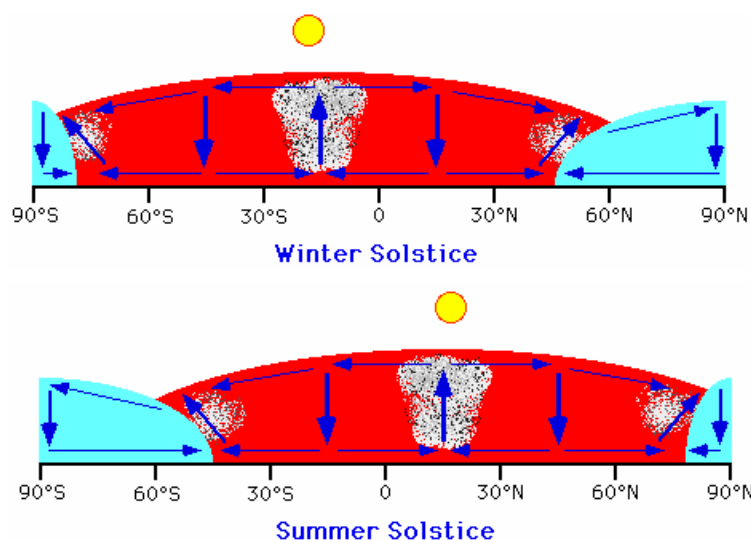

Example: January 20, 2004

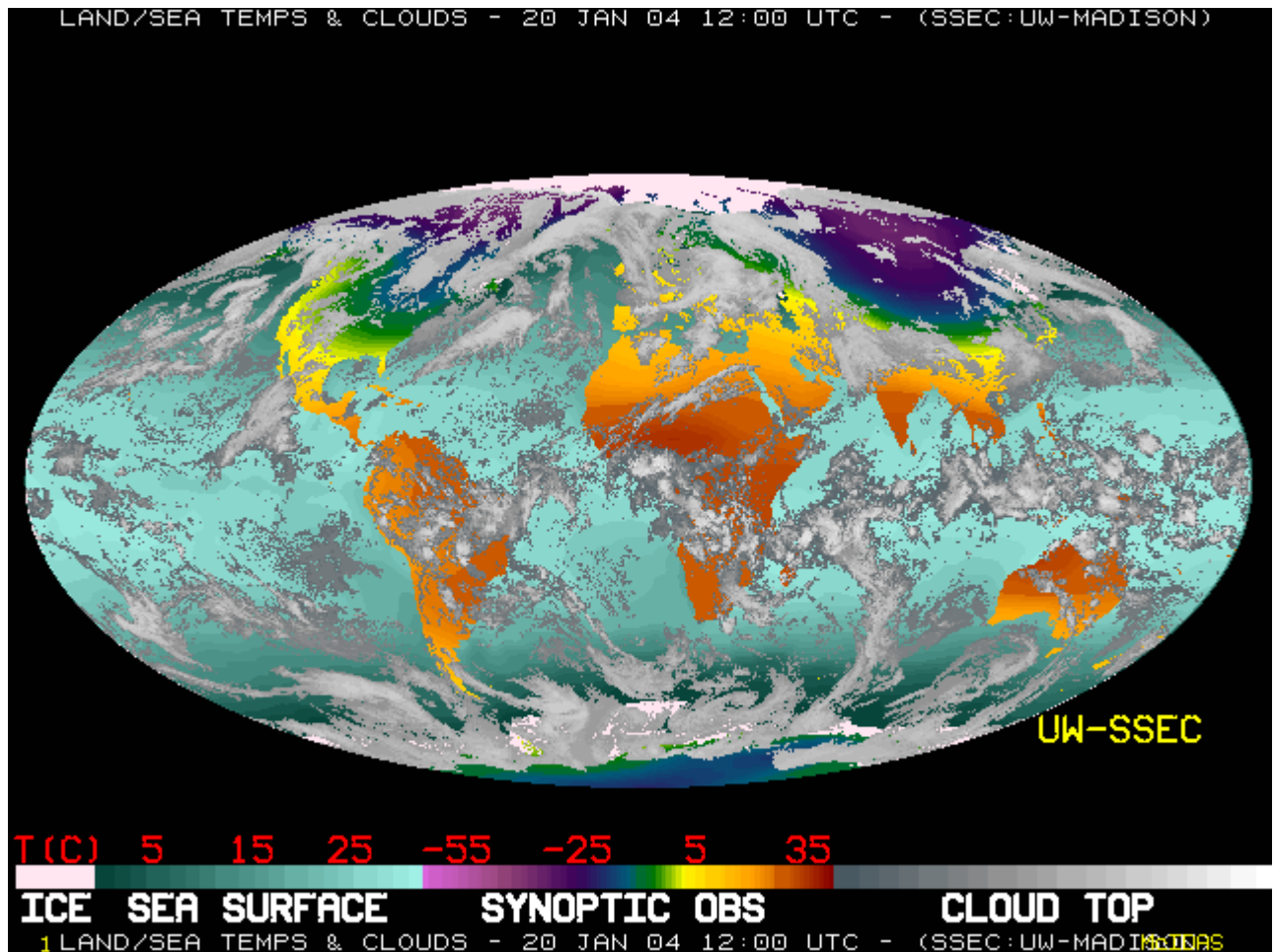

- cloud band from South America over Southern Africa to the Pacific: convection in the ITCZ
- cloud band north of Antarctica
- cloud system from North America to Europe
- no clouds over central Asia
- no clouds over North Africa
- few clouds over southern US / Mexico

Sea-Level Pressure and Surface Winds

Sea-Level Pressure and Surface Winds

JAN

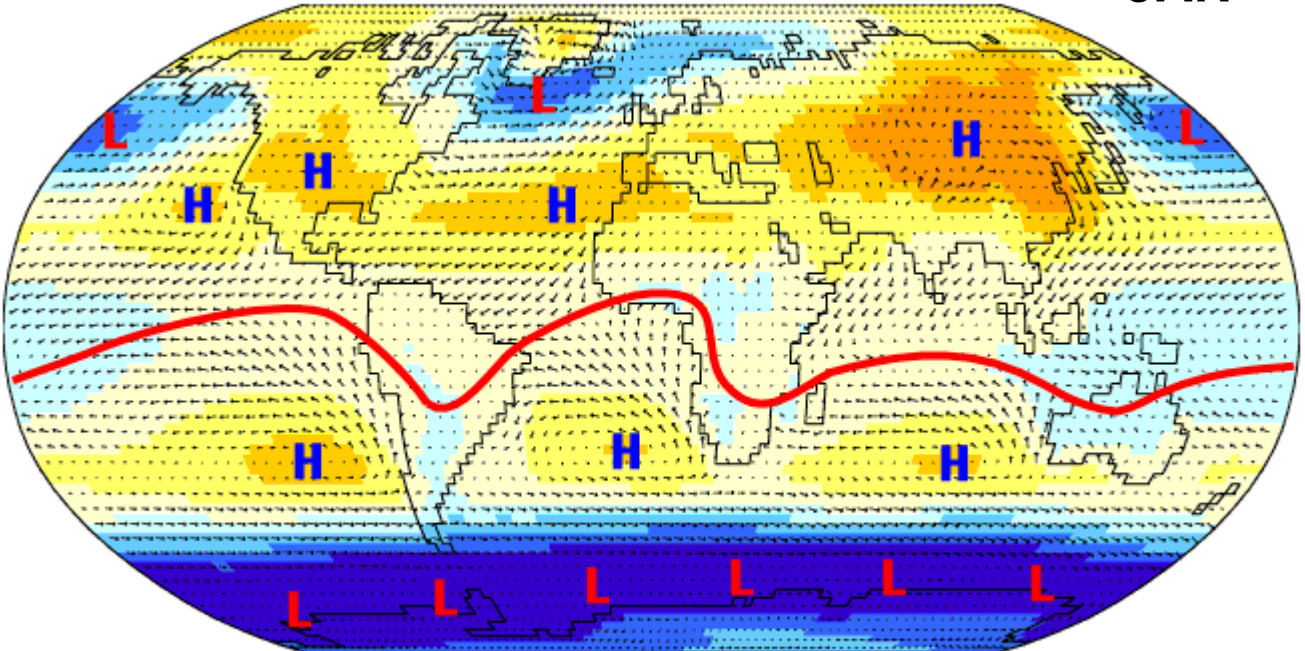

Sea-Level Pressure and Surface Winds

JUL

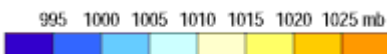
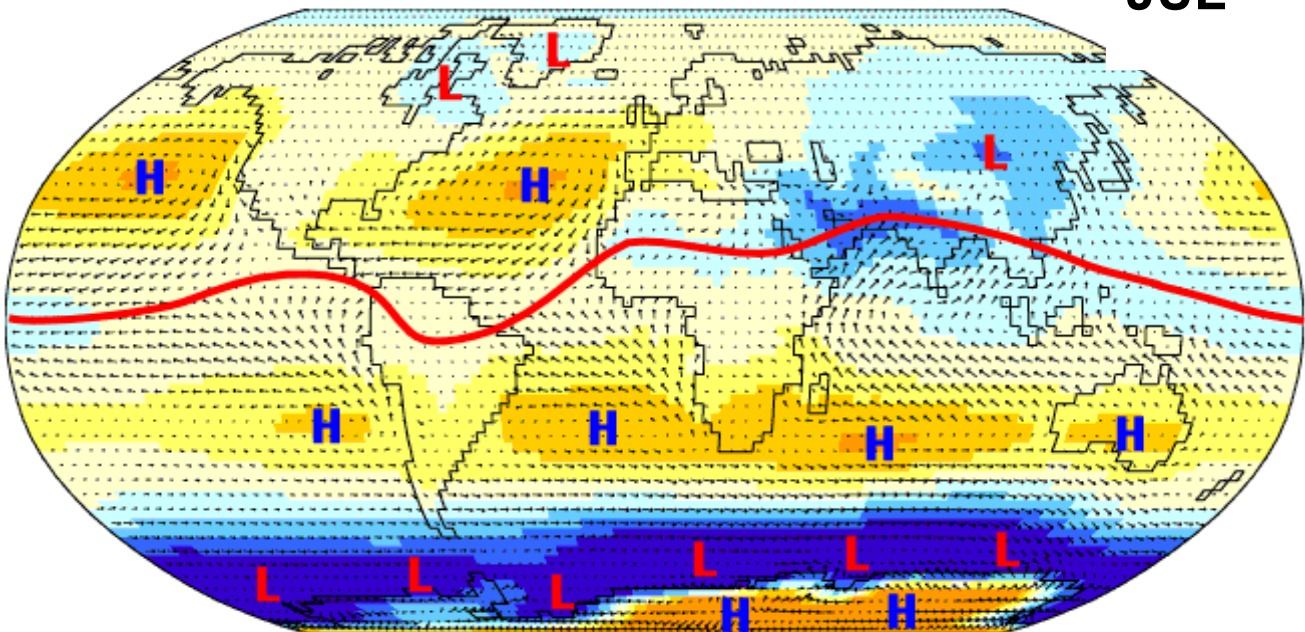

Data: NCEP/NCAR Reanalysis Project, 1959-1997 Climatologies

<http://www.physicalgeography.net/fundamentals/7p.html>

The real situation differs from the simple model because

- land and ocean have very different heating rates and therefore temperature differences establish that change with season
- surface height intensifies pressure systems, in particular high pressure systems
- the tilt of the earth's rotation axis leads to a latitudinal movement of the area of largest and lowest heating

As a result, the **intertropical convergence zone**

- moves with season
- extends further polewards over continents

The **subtropical high pressure zone** is divided into individual high pressure centres intensify where (relatively) cold air masses form, which is over the sea in summer and over land in winter.

The **subpolar lows** form a continuous zone in the Southern Hemisphere but not in the North. They are a result of the large latitudinal temperature differences.

Differences between the Hemispheres

The atmospheric situation is not symmetric with respect to the equator, mainly as a result of the unequal distribution of land masses:

- meridional energy exchange is larger in the NH as friction over the continents and local disturbances of the flow increase the non-geostrophic wind component
- the radiation budget of Antarctica is more negative than that of the Arctic
- zonal winds are less disturbed by topography in the SH

As a result, meridional temperature and pressure differences are much larger in the SH, which leads to higher wind speeds and leads to important differences in the stratosphere (ozone hole).

Another consequence is, that the ITCZ is at 5°N on average, and has very different shapes in summer and winter.

Mass transport in the Circulation

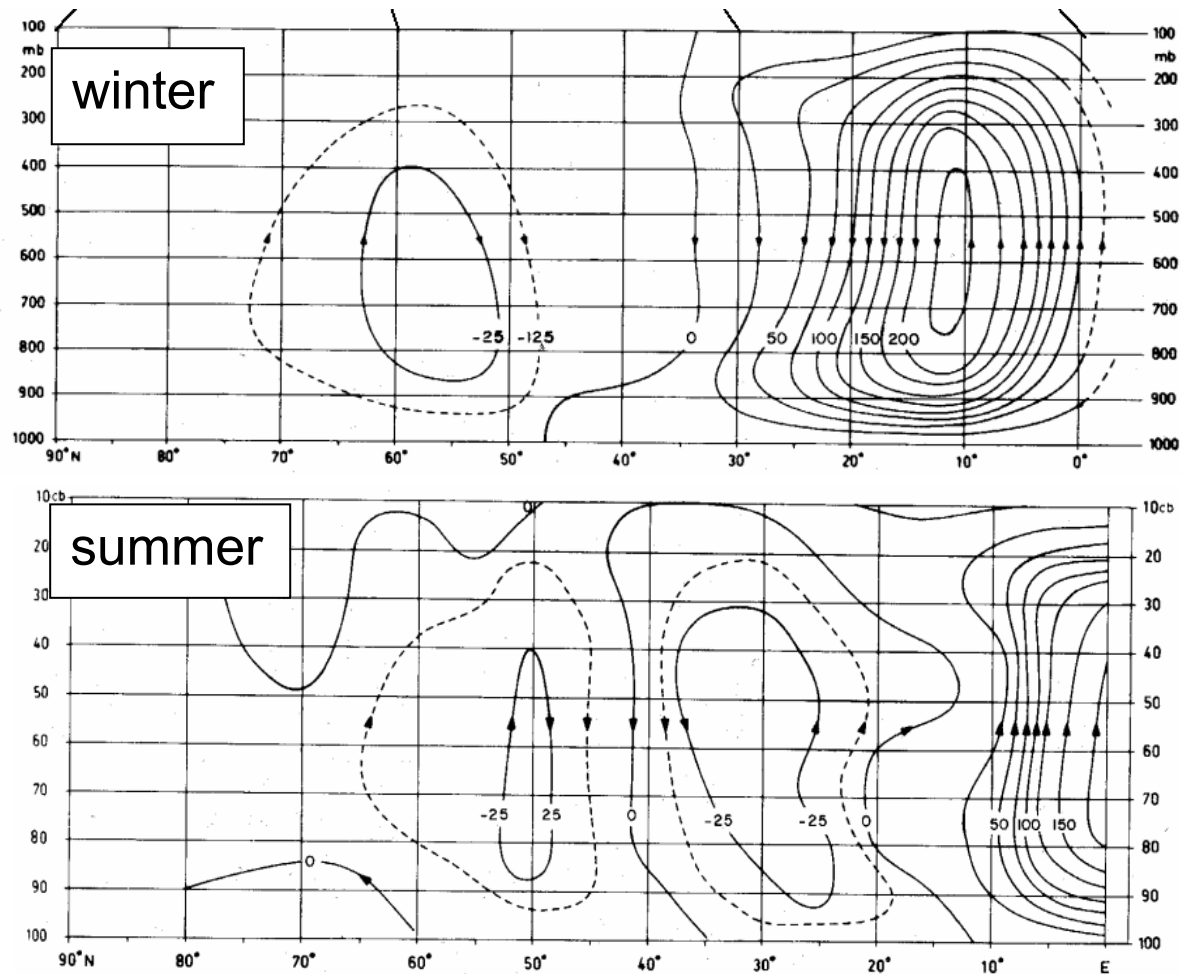

Observed mean meridional circulation in units of mass flux [ton/s]

The turn over of the winter circulation is much larger as that of the summer circulation (10% of the atmospheric mass per month!). The seasonal variation in circulation pattern provides much of the interhemispheric exchange, both in the troposphere and in the stratosphere.

Monsoon

The basic principle behind the monsoon is similar to that of the sea breeze: differential heating over land and sea.

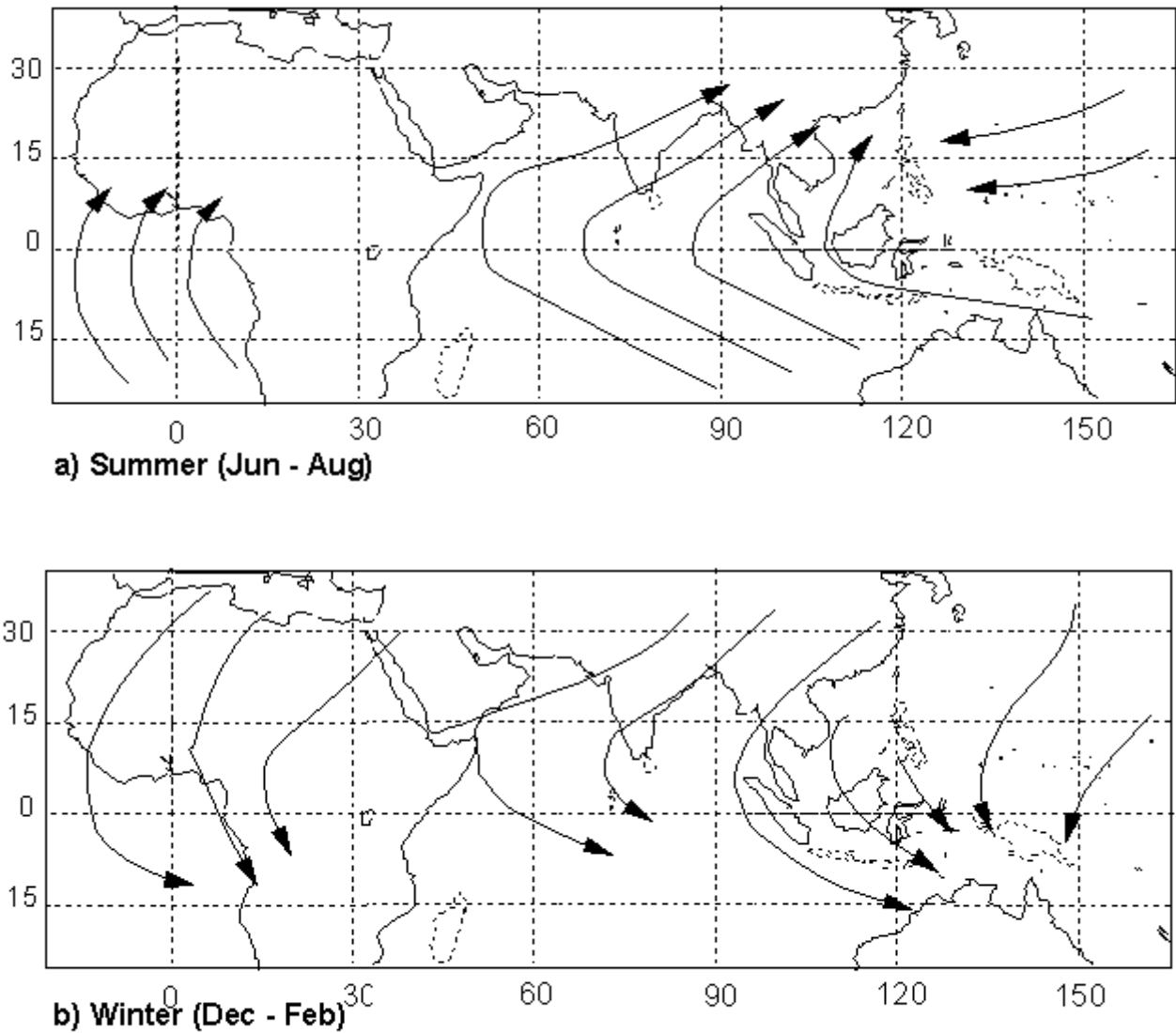

Figure 3. Surface winds during northern hemisphere a) summer b) winter
From: The Elementary Monsoon (Webster, 1987)

In summer, air over the continents warms and ascends, and moist, colder air flows in from the ocean bringing heavy rain. The latent heat release and continuous solar insolation stabilise the circulation which can continue for months. The **winter monsoon** has the same origin but opposite direction as the tropical sea is warmer in winter and brings draught rather than rain. Monsoon patterns extend over East Africa, Arabia, India, and the Arabian Sea. Similar but weaker patterns can also be found in equatorial America.

Summer monsoon over India is a result of the low pressure zone over the Asian highlands that move North with the sun, leading to monsoon patterns appearing first in Sri Lanka end of May and moving to the Himalayas by July. They lead to the highest rainfall values observed anywhere on earth.

Aside: Transport of Pollutants

In the industrialized regions and in regions of biomass burning, large amounts of pollutants are emitted. Many secondary pollutants are the result of intense photochemistry (e.g. ozone). How far pollutants will be transported depends on their lifetime and on wind speeds. Wind speeds are much larger in the upper troposphere, and therefore long range transport is favoured where convection carries things upwards.

The tropics are a very relevant area for large scale pollution because

- interhemispheric exchange dominated by ITCZ movement
- transport from troposphere to stratosphere mainly in the ITCZ
- convective activity in tropical regions favours long range transport of pollutants
- large insolation in the tropics favours photochemistry
- population density and degree of industrialisation is high and increasing

Walker Circulation

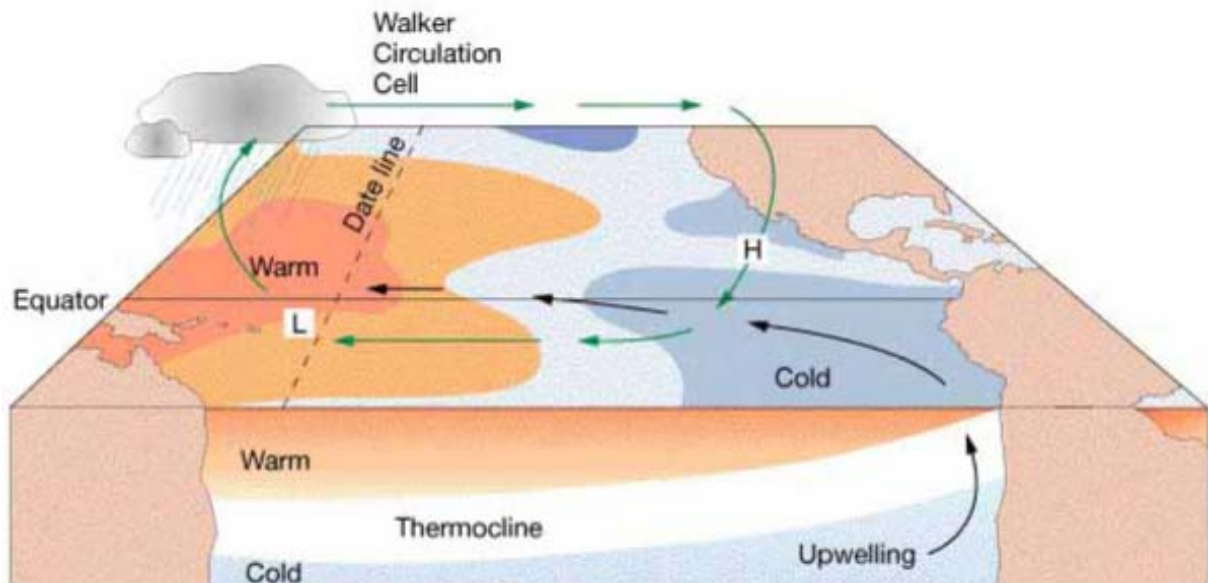

In addition to the meridional circulations, there also is a zonal circulation driven by moist air transported to Indonesia by the trade winds. There, it rises over the warm sea leading to intense convection and the formation of a circulation that brings air back to the eastern Pacific Ocean. The Walker circulation links atmospheric and ocean circulations. It is the key player in oscillations of the tropical weather systems (El Niño, Southern Oscillation) and also to “teleconnections” between tropical and mid-latitude weather.

El Niño / ENSO

In normal years, the Walker circulation is characterized by a low pressure system over the Western Pacific and high pressure over the Eastern Pacific. This leads to

- easterly trade winds
- upwelling of cold and nutrient rich waters off the coast of Peru
- trade winds “pile up” warm water in the Western Pacific (30 cm)
- strong convective activity, storm and precipitation over Indonesian region

During El Niño conditions, the pressure difference reduces and inverts, and

- trades weaken or invert
- warm water from the Western Pacific flows back to the East within 2 months (Kelvin wave)
- upwelling off Peru is interrupted and sea surface temperature (SST) increases
- convective activity moves with the warm water, leading to heavy rain fall at the West coast of SA and draught in the Western Pacific

Model view of El Niño / La Niña:

December - February Normal Conditions

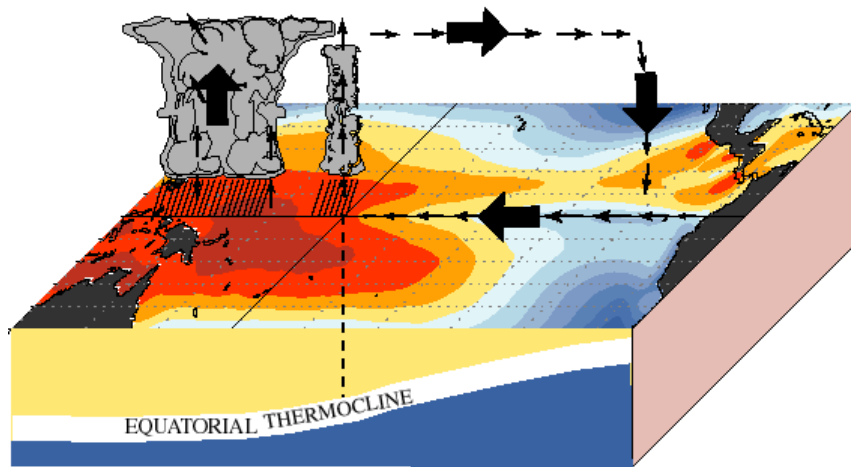

December - February El Niño Conditions

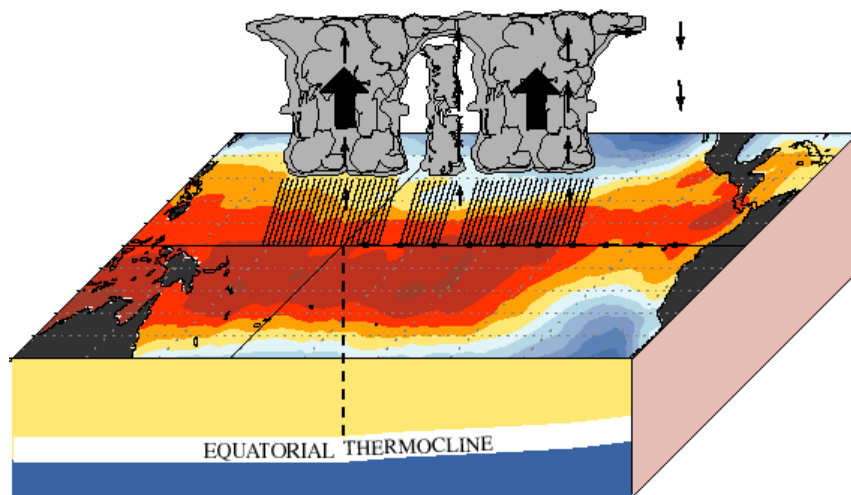

December - February La Niña Conditions

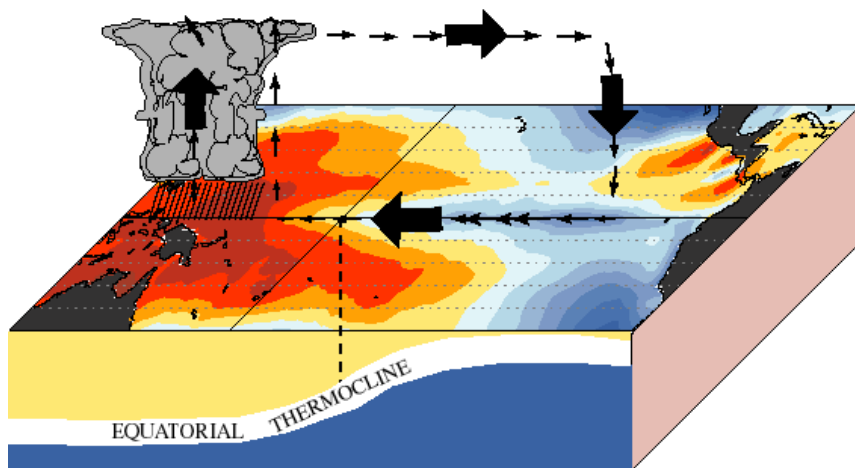

PRESSURE DEPARTURES (mb)

EL NIÑO
Jan-Mar 1998

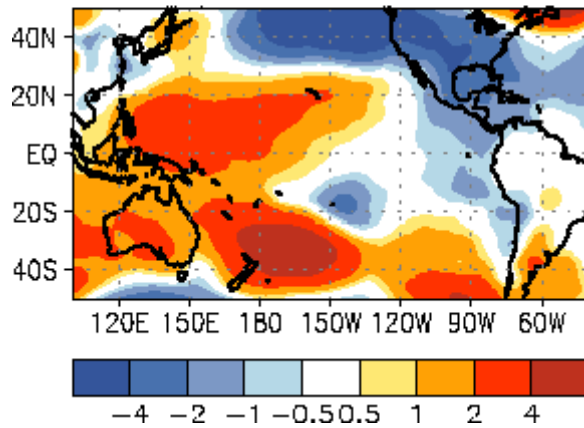

LA NIÑA
Jan-Mar 1989

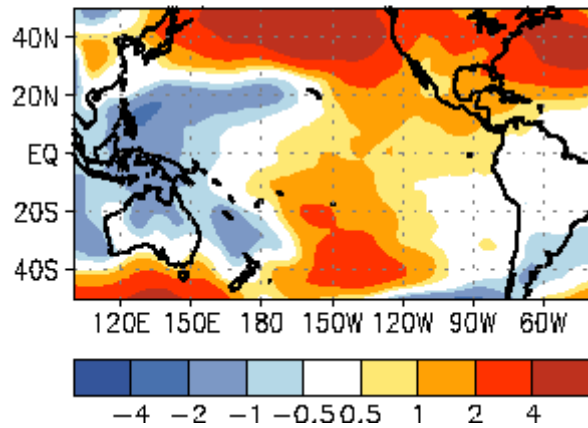

OCEAN TEMPERATURES (°C)

EL NIÑO
Jan-Mar 1998

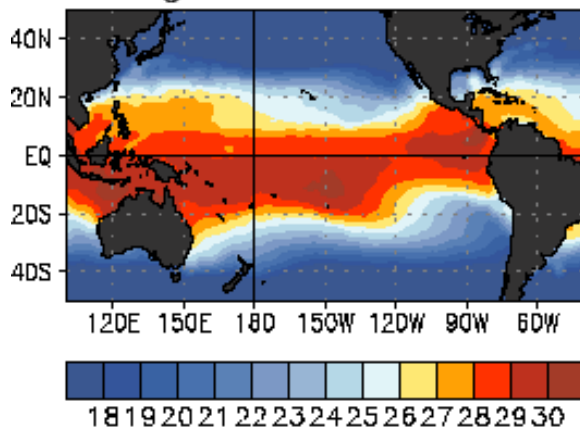

LA NIÑA
Jan-Mar 1989

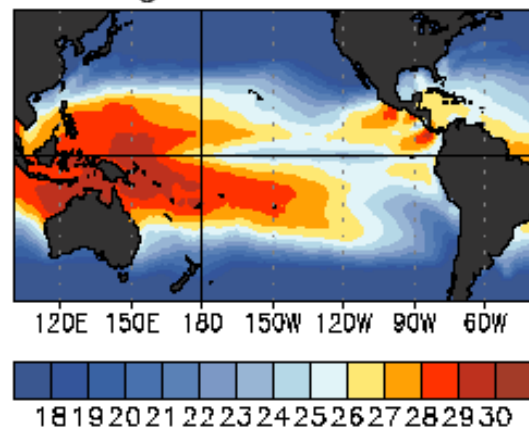

OCEAN TEMPERATURE DEPARTURES (°C)

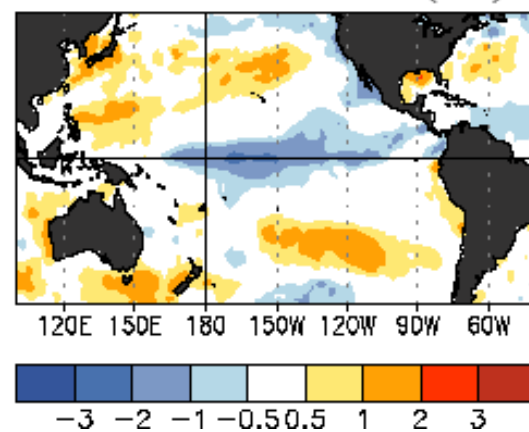
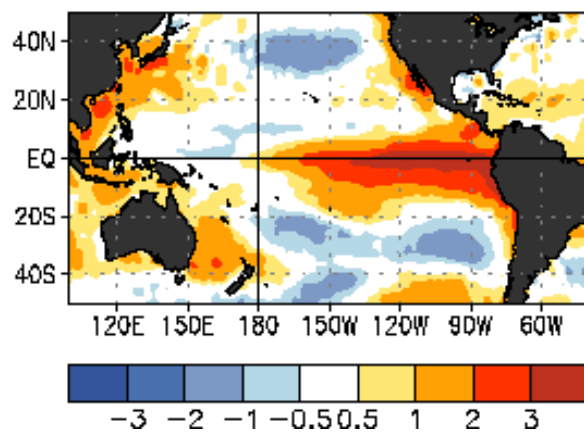

The changes during an El Niño event have many effects on the ocean atmosphere system such as changing flow directions, increased storm frequencies in some regions and reduced landfalling hurricanes in other regions (US). Many areas are subject to unusual draughts (Central America, Philippines, Indonesia, Africa and Australia) which lead to large scale fires which are difficult to extinguish because of the lack of rain.

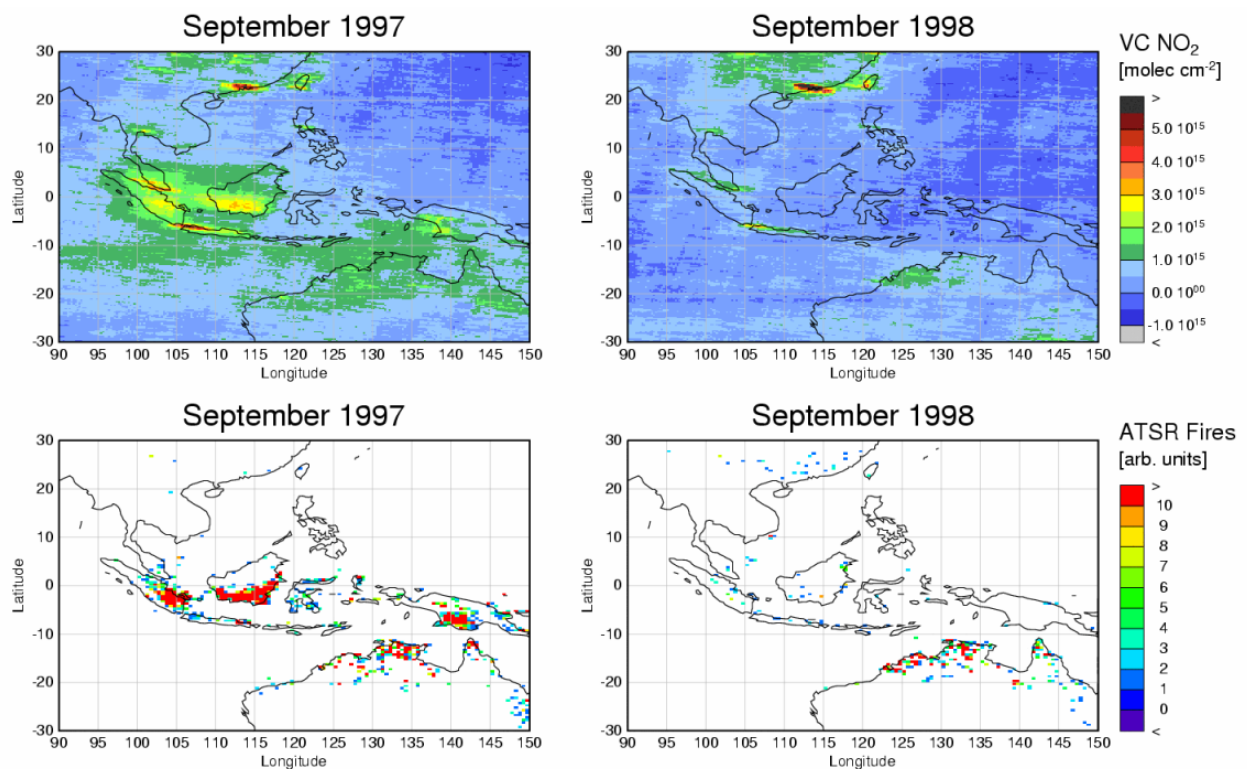

At the same time, other regions (US, Southern America, Southern Europe) experience increased flooding frequencies.

La Niña, Southern Oscillation

At the end of an El Niño event, the high pressure system over the Eastern Pacific re-establishes, and the region of convection moves back to the west. During this period, the normal situation is somewhat exaggerated, again leading to extreme weather conditions, although with less impact on human activities.

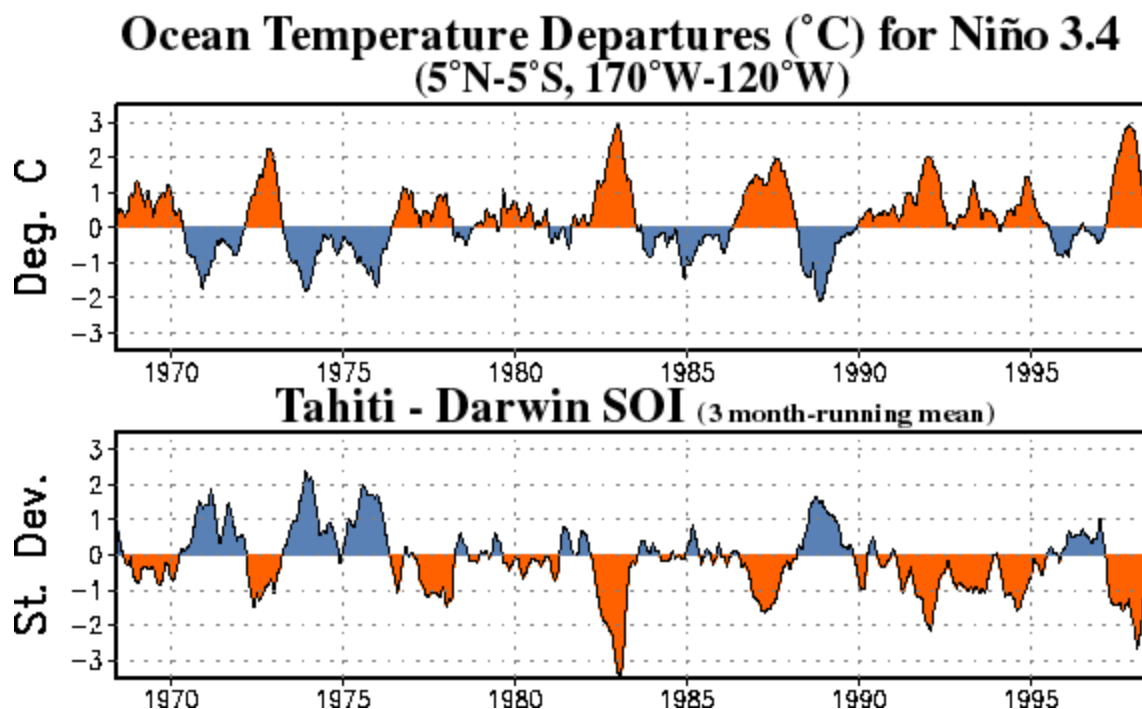

El Niño and La Niña events can be measured by the ocean temperature differences or the **Southern Oscillation Index (SOI)**, that gives the difference of surface pressure between Tahiti and Darwin.

Stratospheric Dynamics

Stratospheric dynamics is driven by similar forces as the tropospheric dynamics:

- temperature gradients, mainly from the tropics to the poles
- Coriolis force
- continuity equation (mass conservation)

The main differences between stratosphere and troposphere are

- the stratosphere has a stable temperature profile
- air density is low
- stratospheric air is very dry (dry freezing of air in the tropopause) => no latent heat release
- air tends to remain on isentropic surfaces for many days; vertical motions are very small
- diabatic processes (mainly heating and cooling through radiation) are relevant
- the tropics are not always warmer than the poles!

In the lower and middle stratosphere, ozone can be used as a tracer for air masses.

see: http://www.ccpo.odu.edu/SEES/ozone/class/Chap_6/

The stratosphere can be divided in several parts:

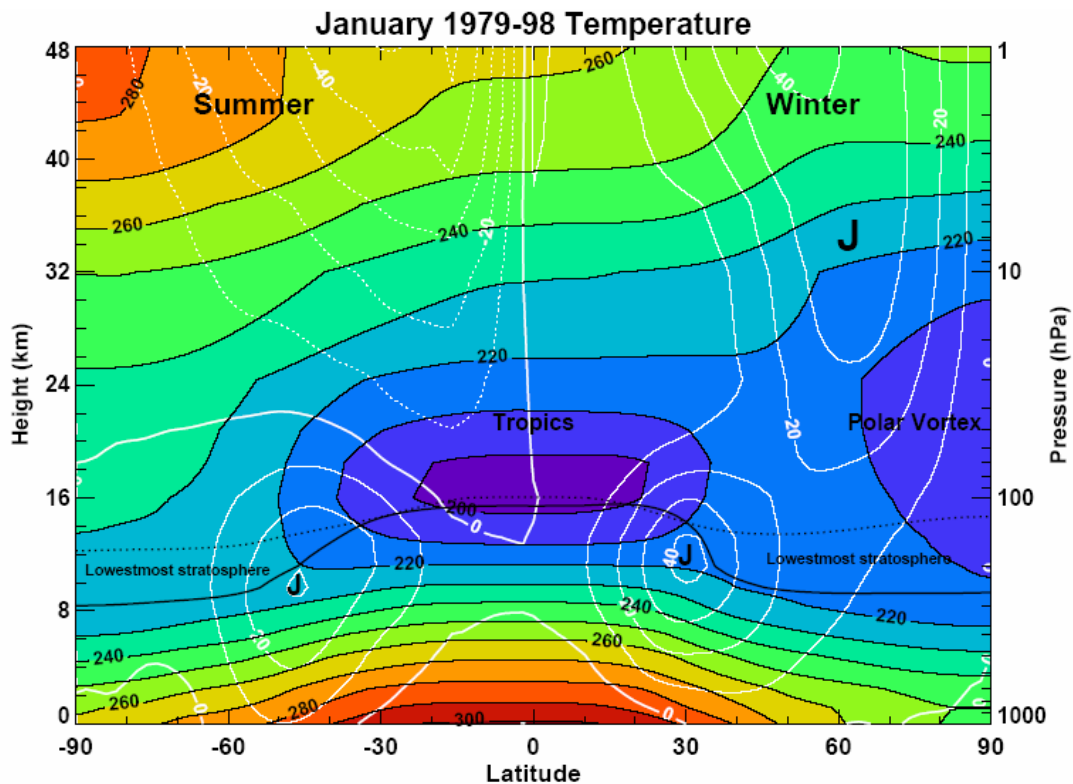

tropics: region $20^{\circ}\text{S} - 20^{\circ}\text{N}$, upward transport of air, ozone formation

surf zone: middle latitudes of the stratosphere - “turbulent” mixing of different air masses, more pronounced in the NH

polar vortex: strong westerlies form in the region of the polar night terminator forming the **polar night jet** which separates polar from mid-latitude air masses

lowermost stratosphere: region of mixture between tropospheric and stratospheric air, roughly between tropopause and 380K potential temperature

The change in temperature gradient between winter and summer hemisphere implies that winds are westerly in winter (Polar Vortex) but easterly in summer. The turn over is observed in spring at the **final warming** which is much later in the SH than in the NH.

Note: the stratospheric polar night jet should not be confused with the tropospheric polar jet stream which is present throughout the year.

In the polar vortex, air cools diabatically by radiation and therefore a net downward movement is observed in the vortex.

Observations show, that stratospheric temperatures in the SH are much lower than in the NH and that the surf zone is less pronounced in the SH. Also, temperatures in the polar vortex are much higher than a simple model would predict from radiation balance. Thus, a mechanism for energy transport from the tropics to the pole must exist.

Brewer-Dobson Circulation

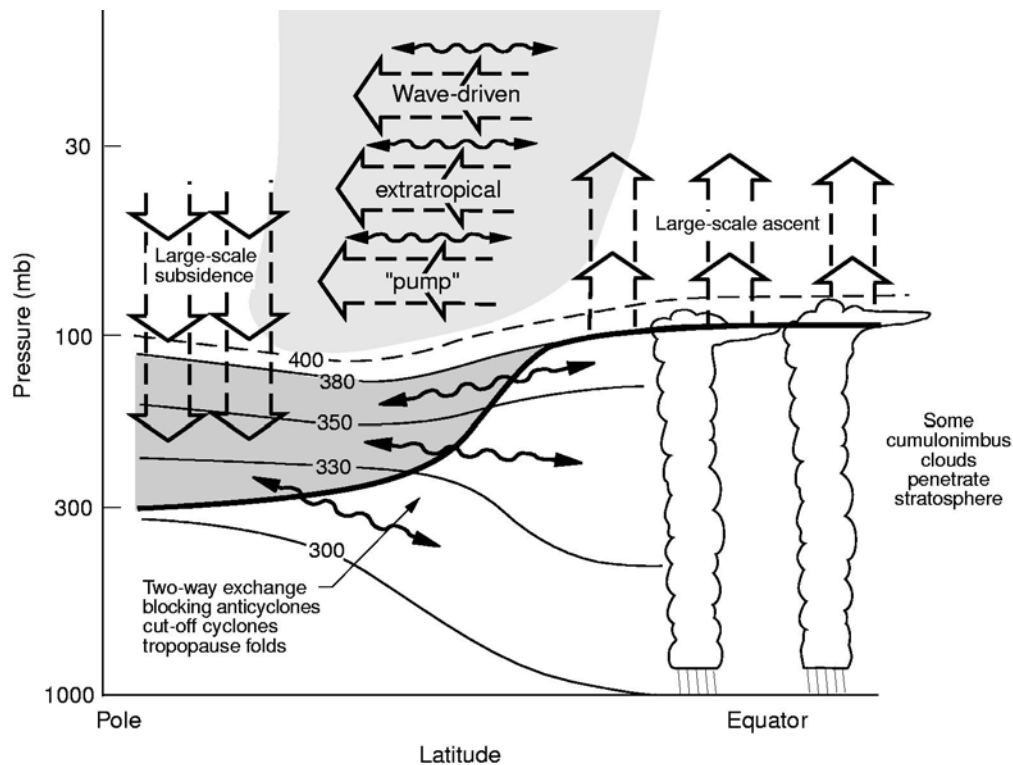

In the winter hemisphere, a circulation establishes that is driven by

- large-scale ascent in the tropics (20-30 m/day)
- descent in the polar vortex
- a wave driven poleward and downward pumping in the surf zone
- stratosphere / troposphere exchange in the lowermost stratosphere

In the summer hemisphere, only a weak circulation exists.

Surf Zone

In the surf zone, large scale planetary (Rossby) waves form, starting in the troposphere and propagating into the stratosphere:

30 mb Geopotential Height

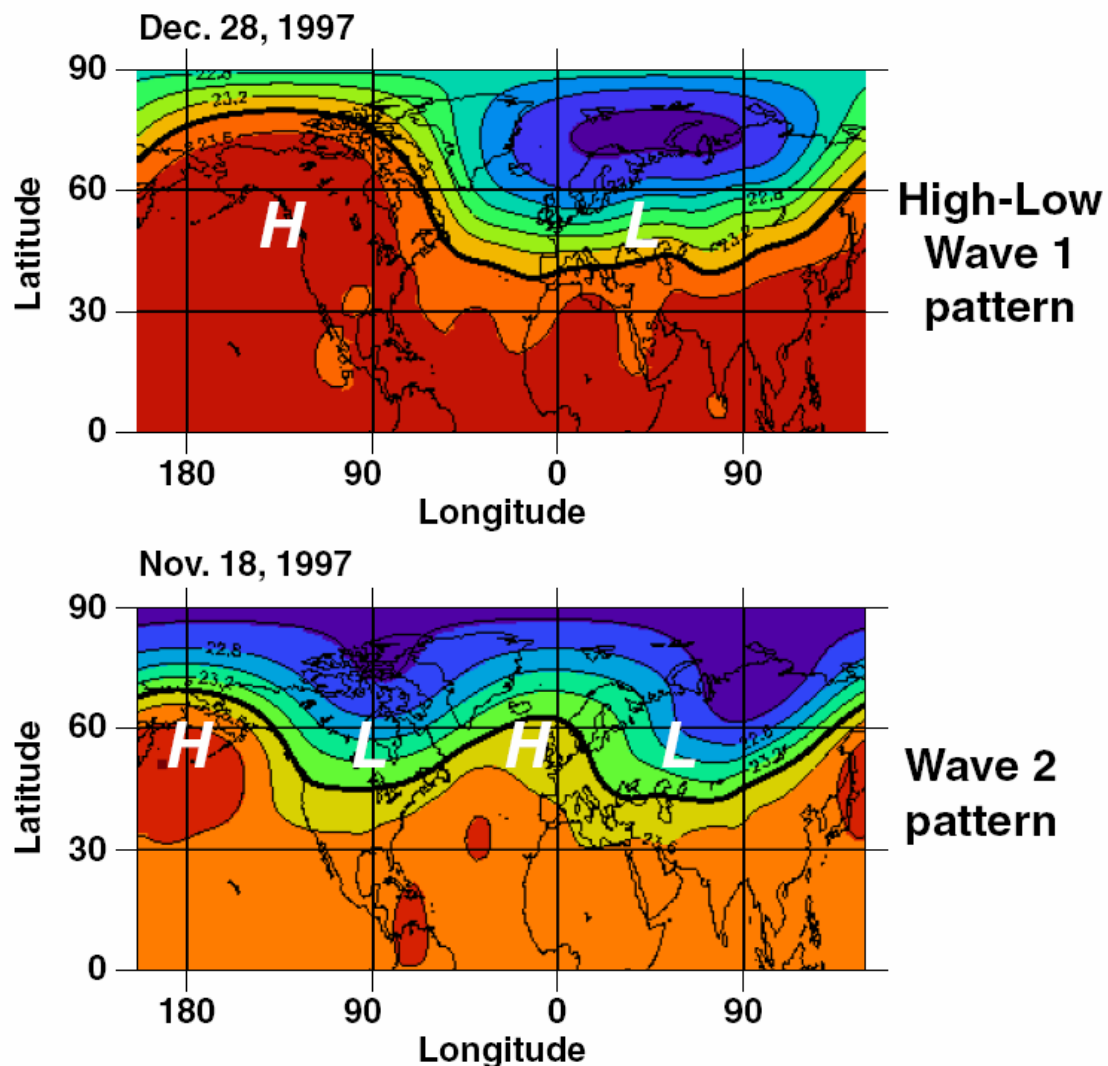

Waves break in the upper stratosphere and deposit energy and easterly momentum there,

which decreases the speed of the westerly wintertime stratospheric jet stream. Decreasing speed means decreasing Coriolis force which induces a poleward component of the flow, similar to the effect of friction on geostrophic wind in the troposphere.

Air RISES over the equator, drifts steadily POLEWARD (while meandering around the latitude circles) and SINKS at the poles.

If the Rossby wave is very strong or the circulation weakened, the temperature gradient can be inverted and the vortex breaks down.

As a result of the smaller land - ocean contrast in the SH, planetary waves are much less frequent in the SH, and therefore transport is weaker, the vortex faster and colder and the time of vortex break up in spring much delayed compared to the NH. This is the prerequisite for the Ozone Hole observed in the southern hemisphere every winter / spring.

Stratospheric Transport by Waves

Waves induced by tropospheric weather systems can trigger strong meridional transport as can be observed in stratospheric ozone measurements:

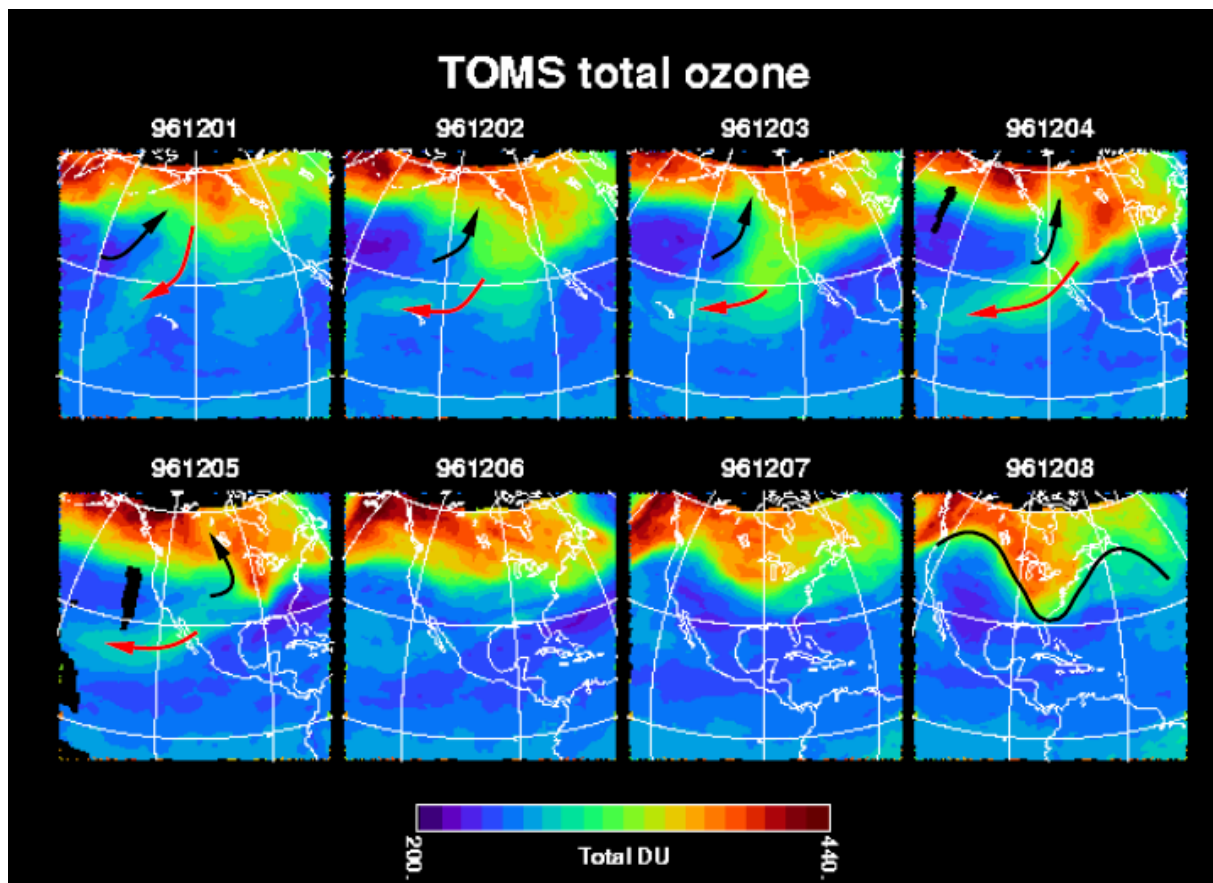

The polar vortex is distorted and shifted by a wave, and low latitude air moves north while polar air moves to the equator. If the extrusion is long enough, it will separate from the vortex and mix irreversibly with the surroundings, constituting a net transport of air (shown here in the ozone field).

Stratospheric Ozone

Stratospheric ozone columns are largely determined by transport. Their magnitude does not correlate well with illumination which is high over the tropics and low in winter at high latitudes. Also, a marked difference between the two hemispheres is observed:

Ozone Column above Bremen, 2001

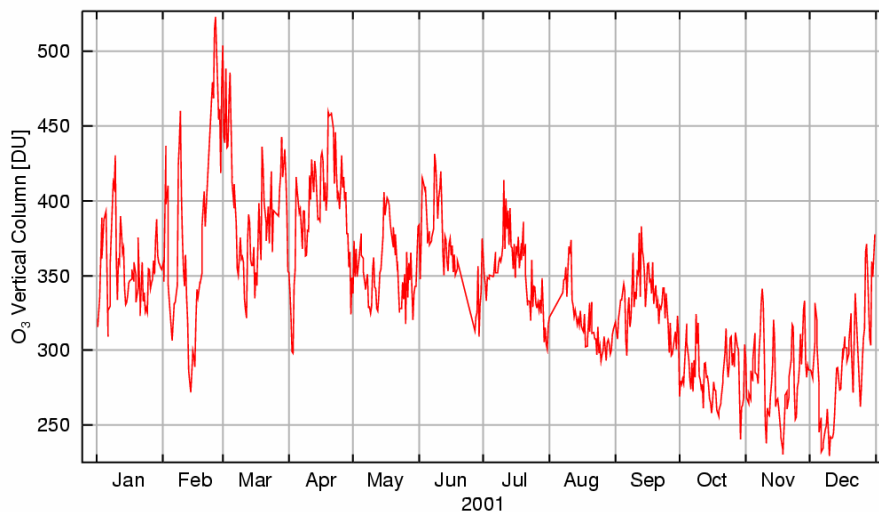

Seasonal Variation of GOME Total Ozone 1997 (DU)

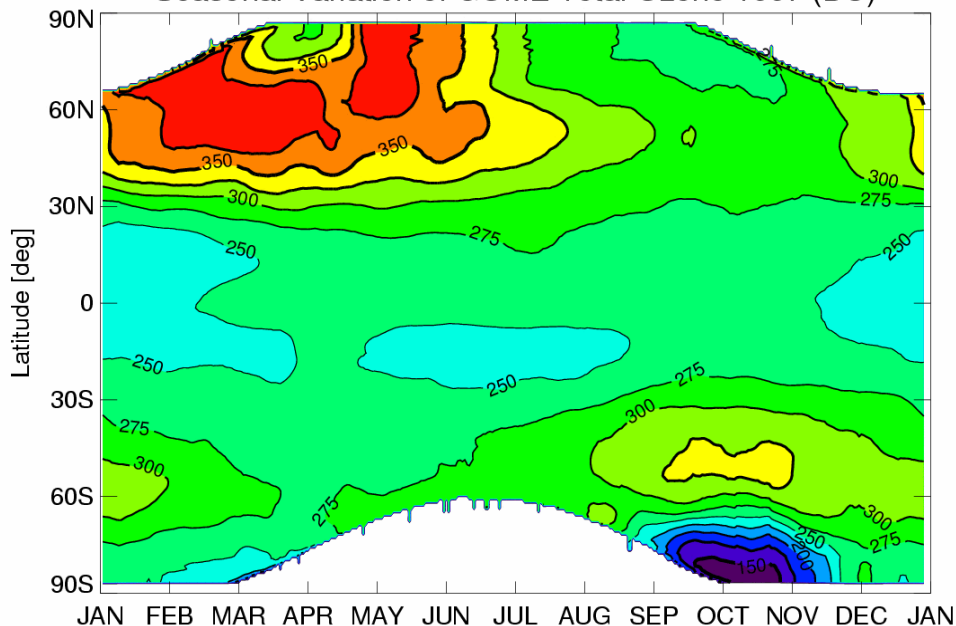

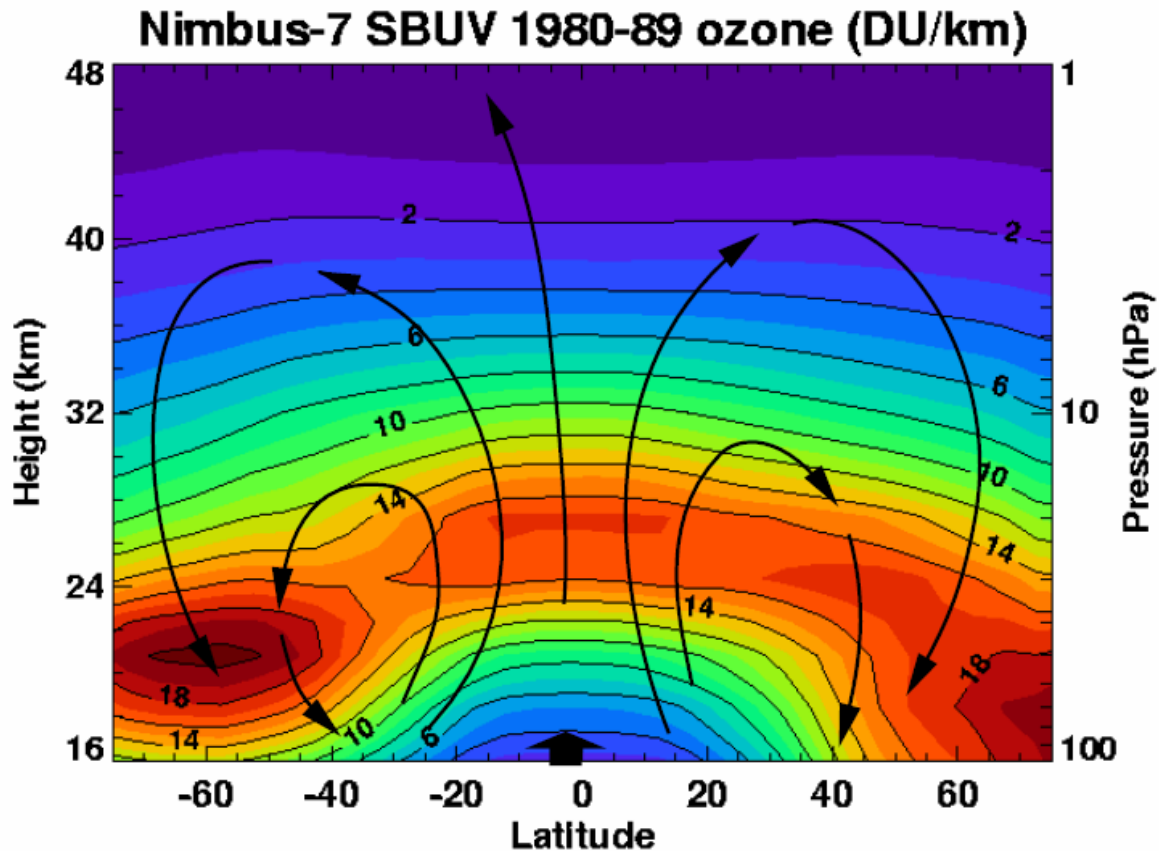

The observed stratospheric ozone distribution (without ozone loss chemistry) can be explained by the Brewer-Dobson circulation:

- formation of ozone in the ascending air in the tropics
- poleward transport
- downward transport and accumulation at mid- and high-latitudes
- largest columns in NH winter polar vortex (less wave activity and thus transport in the SH).

QBO

Observations show that stratospheric zonal winds over the equator ($15^{\circ}\text{S} - 15^{\circ}\text{N}$) change direction roughly every two years (**Quasi Biennial Oscillation**).

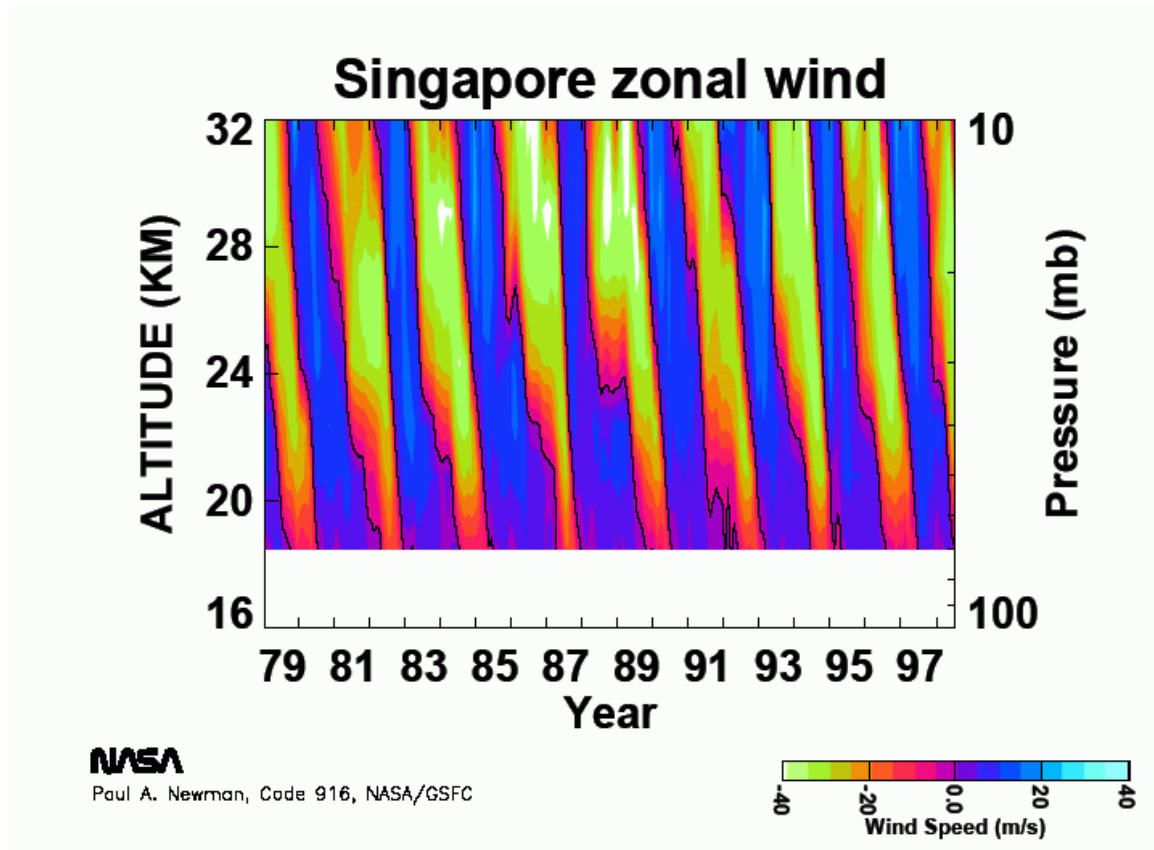

Characteristics of the QBO are

- downward propagation of the wind regimes (1 km / month) from 10 to 100 mbar
- period of 20 - 36 months
- easterlies are stronger than westerlies
- there is considerable variability in amplitude and frequency of the QBO

The theory of the QBO is complicated and not fully developed (many atmospheric models do not create a QBO on their own). It is now thought that equatorially trapped Kelvin waves provide the westerly momentum and Rossby-gravity waves provide easterly momentum to produce the QBO oscillation.

The QBO is linked to many atmospheric processes such as

- ozone columns (changes in transport)
- hurricane frequencies in the Atlantic (lower for easterly QBO)
- ENSO and the monsoon
- major winter stratospheric warmings which preferentially occur during the easterly phase of the QBO

Stratosphere-Troposphere Exchange

Exchange between the stratosphere and troposphere is relevant for anthropogenic influences on the stratospheric ozone layer, climate changes and the link between tropospheric and stratospheric dynamics.

Two different views can be taken on the STE:

1) the global view, where the relevant exchange is through the 380 K isentrope and exchange is governed by the large scale circulation in the stratosphere

2) the local view, where exchange through the tropopause is treated, which is possible through

- convective overshooting in the tropics
- horizontal transport through tropopause folds
- cut-off low pressure systems that become separated from the main flow of the upper tropospheric jet stream, usually associated with blocking patterns and can travel upwards through the tropopause